

# NK-1

## NK-1 Wireless Access Point Controller/NK-1 Network Cloud Patroller

User Manual V1.1



## FCC Certifications



This equipment has been tested and found to comply with the limits for a Class A digital device, pursuant to part 15 of the FCC Rules. These limits are designed to provide reasonable protection against harmful interference when the equipment is operated in a commercial environment. This equipment generates, uses, and can radiate radio frequency energy and, if not installed and used in accordance with the instruction manual, may cause harmful interference to radio communications.

Operation of this equipment in a residential area is likely to cause harmful interference, in which case the user will be required to correct the interference at his or her own expense.

This device complies with Part 15 of the FCC Rules. Operation is subject to the following two conditions: (1) this device may not cause harmful interference, and (2) this device must accept any interference received, including interference that may cause undesired operation.

## CE Mark Warning



This equipment complies with the requirements relating to electromagnetic compatibility, EN 55022 Class A for ITE, the essential protection requirement of Council Directive 89/336/EEC on the approximation of the laws of the Member States relating to electromagnetic compatibility.

The company has an on-going policy of upgrading its products and it may be possible that information in this document is not up-to-date. Please check with your local distributors for the latest information. No part of this document can be copied or reproduced in any form without written consent from the company.

Trademarks:

All trade names and trademarks are the properties of their respective companies.

Copyright © 2016, All Rights Reserved

**WARNING: TO PREVENT FIRE OR SHOCK HAZARD, DO NOT EXPOSE THIS PRODUCT TO RAIN OR MOISTURE. THE UNIT MUST NOT BE EXPOSED TO DRIPPING OR SPLASHING WATER. CAUTION: DO NOT OPEN THE UNIT. DO NOT PERFORM ANY SERVICING OTHER THAN THAT CONTAINED IN THE INSTALLATION AND TROUBLESHOOTING INSTRUCTIONS. REFER ALL SERVICING TO QUALIFIED SERVICE PERSONNEL. CAUTION: THIS DEVICE MUST BE INSTALLED AND USED IN STRICT ACCORDANCE WITH THE MANUFACTURER'S INSTRUCTIONS AS DESCRIBED IN THE USER DOCUMENTATION THAT COMES WITH THE PRODUCT. WARNING: POSTPONE INSTALLATION UNTIL THERE IS NO RISK OF THUNDERSTORM OR LIGHTNING ACTIVITY IN THE AREA.**

# Safety Precautions:

To reduce the risk of fire, electric shock, and injury to persons, always follow basic safety precautions when using this device:

- Read all of the instructions (listed here and/or in the user manual) before you operate this equipment.
- Comply with all warning and caution statements in the instructions.
- Retain the instructions for future reference.
- Observe all warning and caution symbols that are affixed to this equipment.
- Comply with all instructions that accompany this equipment.
- Upon completion of any service or repairs to this product, ask the service technician to perform safety checks to determine that the product is in safe operating condition.
- Installation of this product must be in accordance with national wiring codes and conform to local regulations.
- Give particular attention to all safety precautions.
- Operate this product only from the type of power source indicated on the product's marking label. If you are not sure of the type of power supplied to your home, consult your dealer or local power company.
- It is recommended that the customer install an AC surge protector in the AC outlet to which this device is connected. This is to avoid damage to the equipment from lightning strikes and other electrical surges.
- Wipe the unit with a clean, dry cloth. Never use cleaning fluid or similar chemicals. Do not spray cleaners directly on the unit or use forced air to remove dust.
- Keep the device away from excessive heat and humidity and keep the device free from vibration and dust.
- Do not directly cover the device or block the airflow to the device with insulation or any other objects.

## CONTENTS

FCC Certifications .....	2
CE Mark Warning .....	2
Safety Precautions: .....	3
Quick Controller Overview .....	7
NK-1 Models and Default Setting .....	7
NK-1 Installation.....	8
Setting the NK-1 IP Address.....	9
Configure the NK-1 Wireless Access Point Controller for WK/WX .....	11
The Wizard.....	13
Step 1: IP Address and Firmware .....	14
Step 2: Discover and Manage AP(s) .....	16
Step 3: Global Configuration.....	17
Advanced Settings in Global Configuration.....	19
Guest network (optional).....	19
Dashboard.....	20
Dashboard & Widgets .....	21
Reports.....	22
Summary.....	23
Detailed.....	23
Custom .....	23
Client list.....	24
Client History .....	24
Events.....	25
Settings .....	25
Macrocell Controller .....	25

Administration.....	26
Maintenance.....	26
Controller Firmware.....	27
Time and Date .....	27
LAN Settings.....	28
License .....	28
Access Point.....	29
Manual setup .....	29
LED Controls.....	30
AP Reboot .....	30
Access Point Firmware .....	31
Adding an Additional Access Point.....	31
Global Configuration.....	32
Advanced .....	33
MAC Filtering .....	33
Client Limit.....	34
Scheduling .....	34
Dealer Tools .....	34
Site Survey .....	34
AP Deployment.....	35
Wireless Optimization.....	42
Configure the NK-1 Wireless Access Point Controller for W6/W7.....	44
The Wizard.....	46
Step 1: Firmware.....	46
Step 2: Discover and Manage AP(s).....	47
Step 3: Global Configuration .....	48

Advanced settings in global configuration.....	51
Guest network (optional) .....	51
Access Point Overview .....	54
Dashboard .....	54
Reports .....	57
Settings .....	59
Macrocell Controller.....	59
Access Point.....	62
Manual.....	63
LED Controls.....	64
AP Reboot .....	64
Access Point Firmware .....	64
Adding an Additional Access Point.....	65
Global Configuration.....	66
Advanced .....	66
Mac Filtering .....	67
Client Limit.....	70
Scheduling .....	71
Site Survey.....	73
AP Deployment.....	75
Configuring the NK-1 Network Cloud Patroller .....	84
Step 1: Login .....	84
Step2: Changing the IP Address of the Patroller.....	85
Creating a Pakedge Cloud Account from the Cloud .....	86
Create Pakedge Cloud Account and Register the NK-1 Patroller .....	86
Registering the Patroller with an Existing User.....	88

Accessing Mybakpak.....	90
Technical Support.....	91
Limited Warranty.....	91

## Quick Controller Overview

The front panel of the NK-1 has a pair of yellow LEDs. See the below table for more information.

Label	Function	Description
PWR	Power indicator light	When lit, indicates that unit has power
Maintenance	Maintenance port indicator light	When lit, indicates that Maintenance port is in use
LAN	LAN port indicator light	When lit, indicates that LAN port is in use
USB	USB indicator light	When lit, indicates that USB port is in use

The rear panel is where the physical cabling (power, Ethernet, console) is located. The table below describes each port and its function.

Name	Description
Power Switch	Turn on/off the NK-1
AC Connector	AC110 ~ 240V
Console	Local management, 115200bps, RJ45 interface
LAN	MDI/MDIX RJ45 interface for connection to the LAN
Maintenance	Maintenance
USB	Maintenance
Reset	Factory default the NK-1

## NK-1 Models and Default Setting

### NK-1

The NK-1 model can be identified by following labels:

- **Wireless Access Point Controller**

You can find the “Controller” label on NK-1’s rear panel and “Controller FW loaded” label on the box.

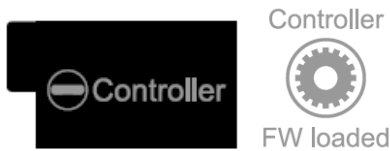

Please refer to following label that indicates how many access points that the controller is able to manage. It follows your order of NK-1.

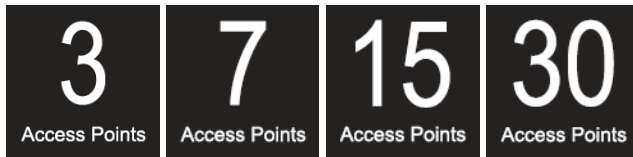

- **Network Cloud Patroller**

You can find the “Patroller” label on NK-1’s rear panel and “Patroller FW loaded” label on the box.

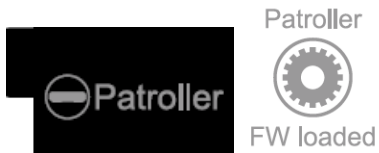

**Note:** The NK-1 can be upgraded in the field to include both the Wireless Access Point Controller and the Network Cloud Patroller. Each application can also be purchased separately.

## NK-1 Default Settings

IP Address: **192.168.1.240**

Username/Password: **pakedge/pakedgen**

# NK-1 Installation

Tools required:

- Phillips screwdriver (if using rack-mount brackets).
- PC or laptop with Ethernet interface and a web browser (an integrated DB-9 port or USB-to-Serial adapter may be necessary if you would like to use the console interface).
- Ethernet cable.

## Installation

1. Open the box and remove the unit.
2. If mounting NK-1 in a standard 19" AV rack, attach the rack-mounting brackets that come with the NK-1. If not rack-mounting, ensure that NK-1 is physically mounted near power and network connections (i.e, backbone switch or firewall/router).

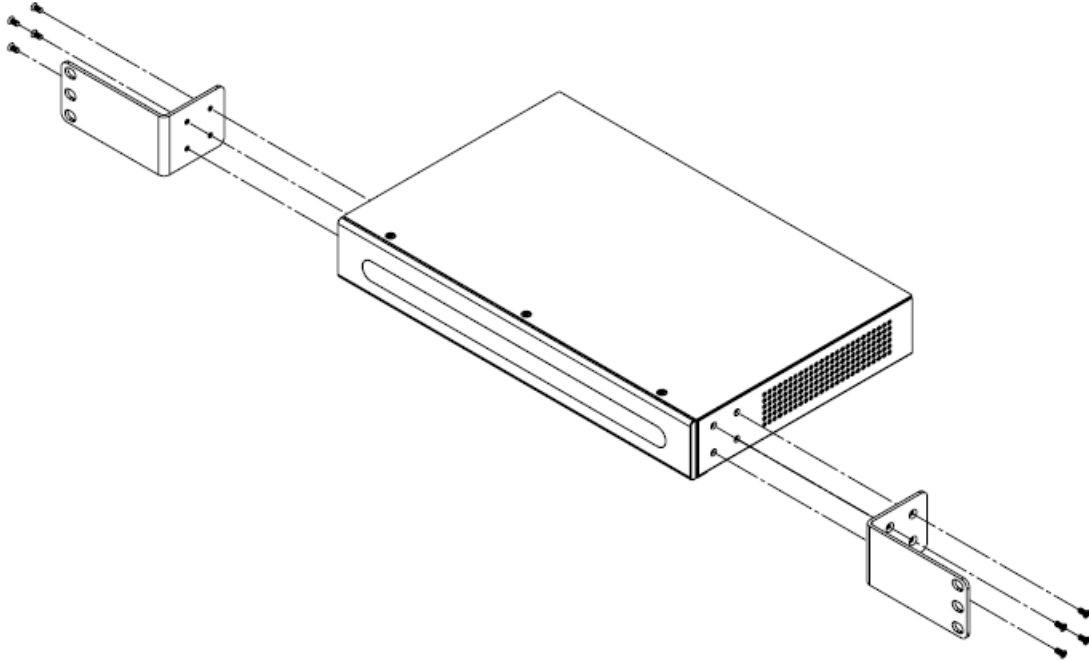

3. Connect power to the device.
4. Connect an Ethernet cable from your computer to the LAN port on the NK-1.
5. You are now ready to configure the NK-1 to an IP address that matches your network.

## Setting the NK-1 IP Address

### **Configure the NK-1 with a router in your network:**

If you are using a router that has an internal IP address of 192.168.1.X, then you can connect the controller to an available port on your router or a network switch and skip the The Wizard. Connect an Ethernet cable from the NK-1 to your router while the router is on.

### **Configure the NK-1 using a PC directly:**

If your router is using an IP scheme other than 192.168.1.X, or you want to configure the NK-1 directly using a PC, you can connect an Ethernet cable from your computer to the NK-1. Configure the PC with a static IP address of 192.168.1.10 and subnet mask of 255.255.255.0, as shown following:

## Using Windows 10

Under **Control Panel – Network and Internet**, click on **View Network Status and Tasks**.

On the left panel, click on **Change Adapter Settings** and right-click **Local Area Connection**. Select **Properties**.

Select **Internet Protocol Version 4 (TCP/IPv4)** and click **Properties**.

Select Use the following IP address and enter the following information:

IP Address: **192.168.1.10**

Subnet Mask: **255.255.255.0**

Additional settings can be left blank.

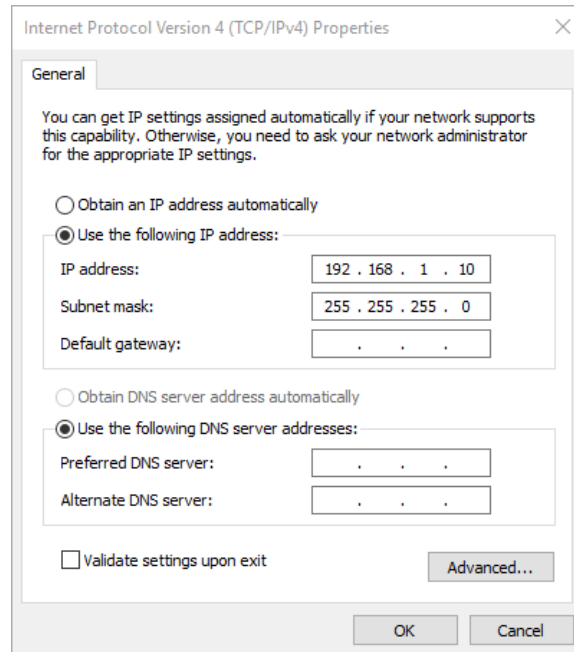

Click **OK** and Close.

## Using OS X

Under **System Preference – click Network**.

On the left panel, click on **Ethernet** (Thunderbolt Ethernet on newer macs) and select **Manually** from the dropdown.

Enter the following information:

IP Address: **192.168.1.10**

Subnet Mask: **255.255.255.0**

Additional settings can be left blank.

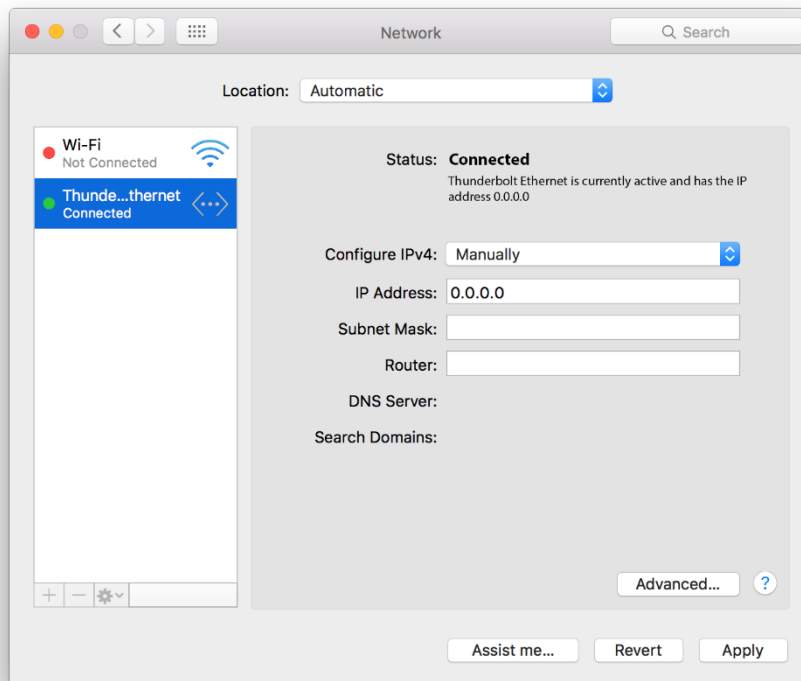

Click **Apply** and Close.

## Configure the NK-1 Wireless Access Point Controller for WK/WX

If your NK-1 model is the NK-1 Network Cloud Patroller, please skip to the section of **Configuring the NK-1 Network Cloud Patroller**.

The following section is for configuring NK-1 wireless access point controller that is compliance with WK-1, WK-2 and WX-1. If your wireless access points are W6/W7 series, please skip to the section "Configure the NK-1 Wireless Access Point Controller for W6/W7".

1. In the browser, enter the NK-1's default IP address of 192.168.1.240 into the address bar and press <ENTER>.
2. A webpage will appear prompting you for a username and password. Enter **pakedge** as the username and **pakedgen** for the password. Then click **Login** to log in to the web administration portal.



3. Once you have logged into the controller, you will see the Dashboard.

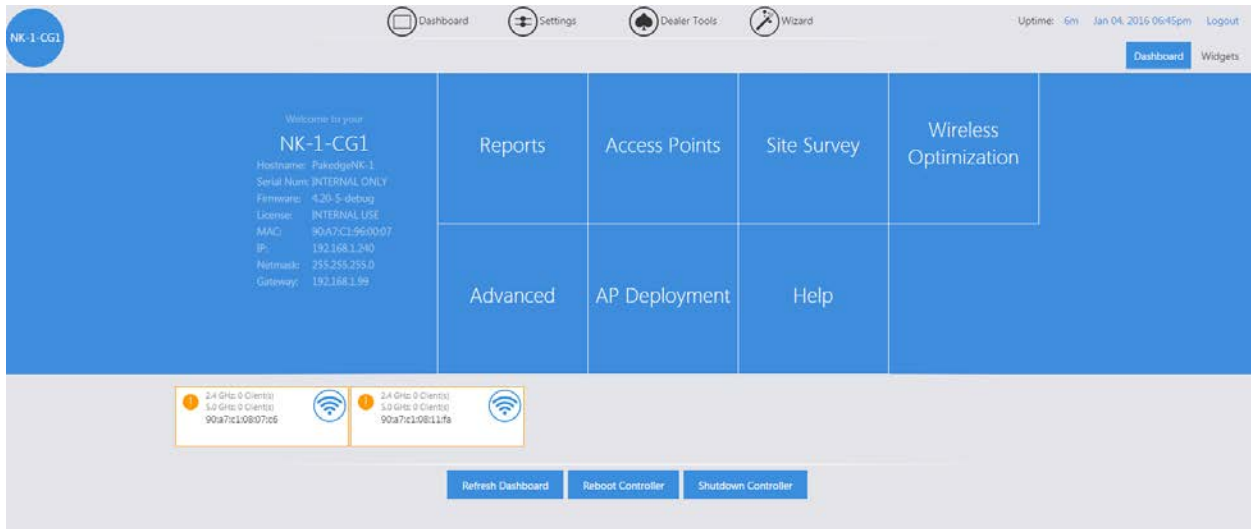

4. Hover your mouse over **Settings** towards the top. Click **Macrocell Controller**.

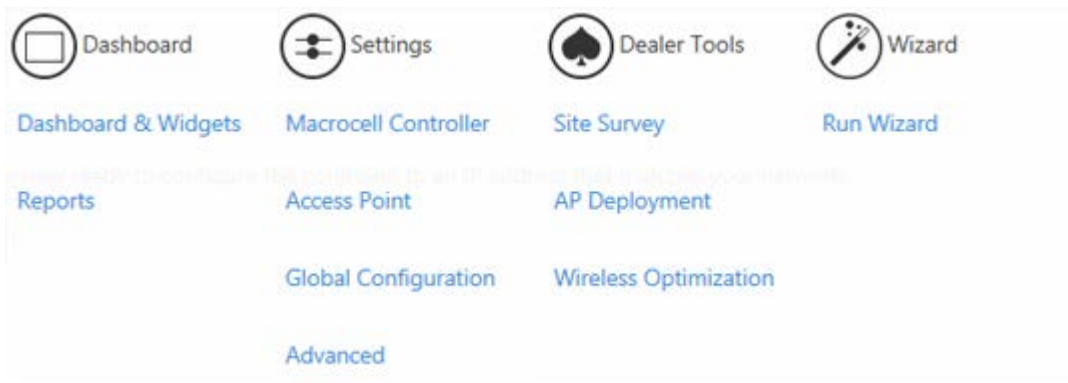

5. Click **LAN Settings**.

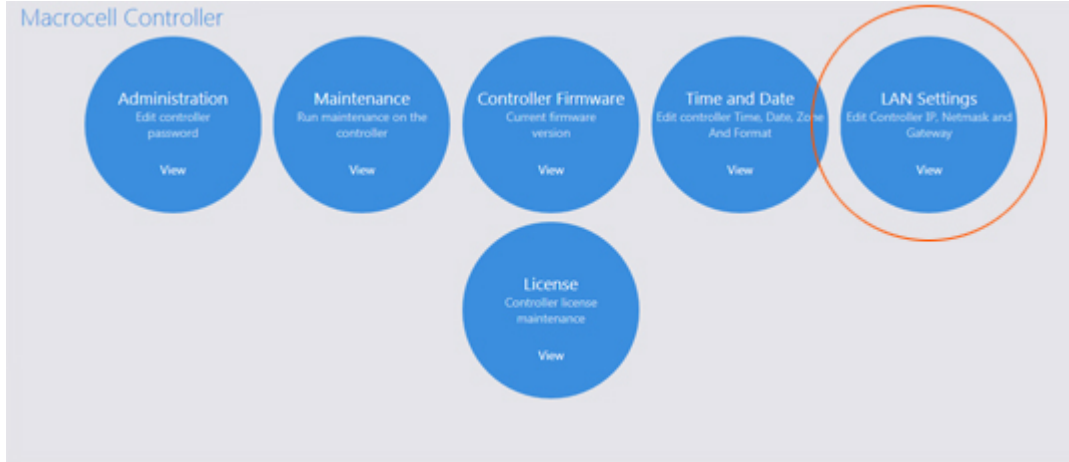

6. Enter the correct IP address information. Click **Save** to finalize the settings. You can now connect the controller to your network and run **Wizard**.

The image shows the LAN Settings configuration page with the following fields and values:

LAN Settings	
IP:	192.168.1.240
Netmask:	255.255.255.0
Gateway:	192.168.1.99
Hostname:	PakedgeNK-1
<input type="button" value="Save"/>	

## The Wizard

The Wizard will discover, manage and configure your access points, making it a quick and easy tool for getting your wireless network set up and running.

**Note:** If this is your first time logging into the NK-1 Controller, you will be prompted to run the **Wizard**.

## AP(s) Configuration

The c36 has detected that your AP(s) have not been configured.  
Would you like to run the Wizard to guide you through the configuration process?

Run Wizard

Cancel

Otherwise, log in to the NK-1 controller and hover your mouse over the Wizard towards the top. Click **Run Wizard**.

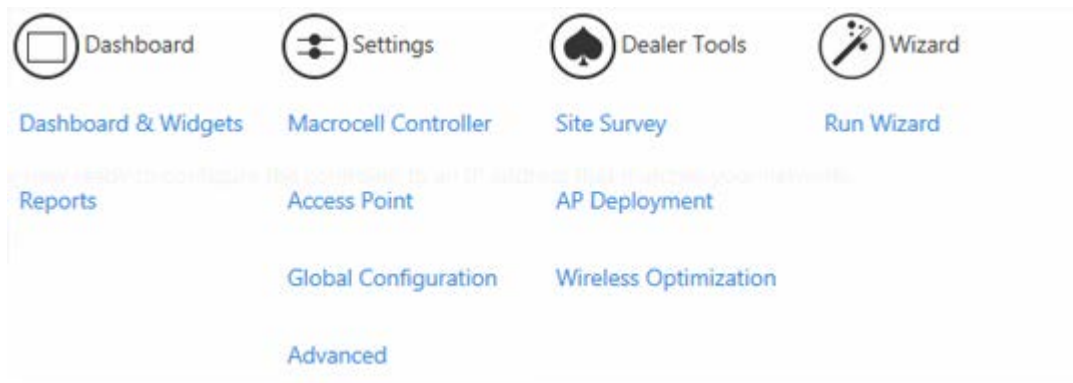

Click **Start** to begin the wizard setup.

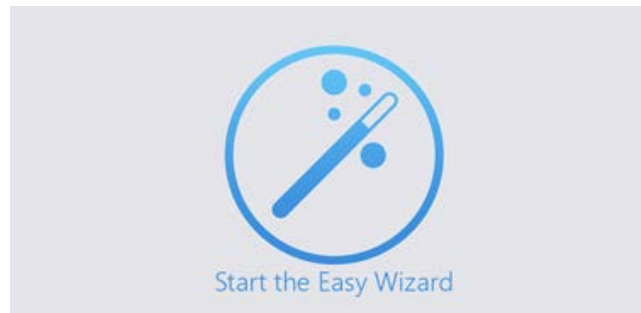

## Step 1: IP Address and Firmware

If your WK-1/WX-1 has the default 192.168.1.250 or a duplicate IP address, the NK-1 controller will ask you to configure the IP address of your access point.

## Duplicate/Default IP Addresses Found

1 Duplicate/Default IP Addresses Found.  
Please apply DHCP or set Static IP Addresses to continue.  
You will be able to update the firmware afterwards.

Select "Static" or "DHCP"

Apply DHCP	Static IP	Cancel
------------	-----------	--------

Click **Apply DHCP** to get the dynamic DHCP from your router in the network. Please make sure your router is on and can assign IP addresses correctly.

Click **Static IP**, input your desired IP address range in the blanks, and click **Set**.

## Specify IP Range

From:	To:		
192.168.1. <input type="text" value="111"/>	192.168.1. <input type="text" value="111"/>		
Subnet Mask			
<input type="text" value="255"/>	<input type="text" value="255"/>	<input type="text" value="255"/>	<input type="text" value="0"/>

IP Address Currently in Use

192.168.1.252 192.168.1.250 192.168.1.236 192.168.1.99

Set	Cancel
-----	--------

If the IP address of your WK/WX has been configured, this step will be waived.

The access points must all be on the same firmware version. If there is any inconsistency in the firmware version, the NK-1 will notify you as following:

## Update AP(s)

1 of your AP(s) have an older firmware and must be updated.

To update now, click "ok"

Ok	Cancel
----	--------

Click **Ok** to upgrade to latest AP firmware. The firmware upgrade process will take a few minutes.



Once you see the following message, you will know the update was successful.

## AP Firmware



The AP(s) have the latest firmware. No update is required.

Close

Once the firmware upgrade is completed, you will be redirected to the AP-Firmware update page.

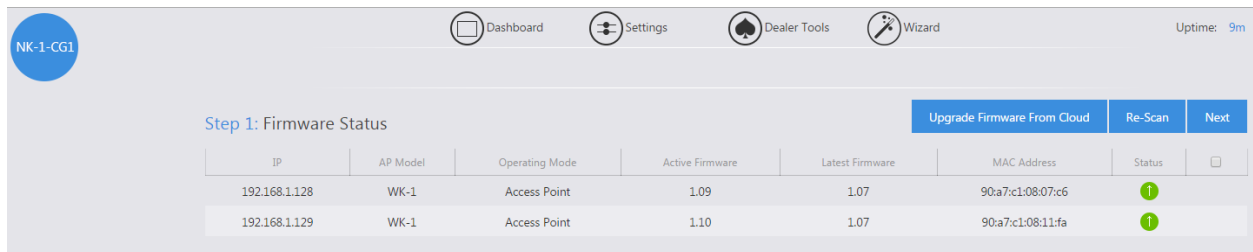
The icon -  indicates which access points have an older firmware and which version they should be updated to. Select the highlighted APs and click on **Upgrade**. Once the process is complete, all your access points should display a green icon like this: 



IP	AP Model	Operating Mode	Active Firmware	Latest Firmware	MAC Address	Status	
192.168.1.128	WK-1	Access Point	1.09	1.07	90a7:c1:08:07:c6		
192.168.1.129	WK-1	Access Point	1.10	1.07	90a7:c1:08:11:fa		

Click **Next** to continue to the next step.

## Step 2: Discover and Manage AP(s)

The NK-1 controller will detect the DHCP server on the network, which is usually a router. Click **Next** to continue.

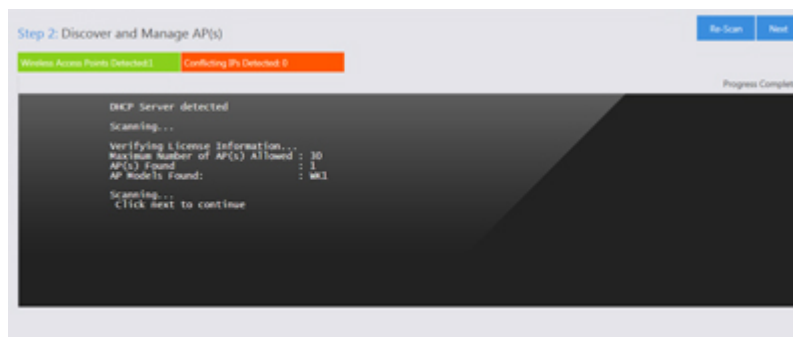

```

DHCP Server detected
Scanning...
Verifying License Information...
Maximum Number of AP(s) Allowed: 30
AP(s) Found: 1
AP Models Found: WK1
Scanning...
Click next to continue
  
```

## Step 3: Global Configuration

The screenshot shows the 'WK Global Configuration' interface. At the top, there are two dropdown menus: 'Select Number of SSID's to Broadcast' set to '1' and 'Enable Band Steering' set to 'Enabled'. Below this, a large blue circle on the right contains the text 'SSID 1'. The main configuration area includes the following fields:

- SSID:** C36-1-2.4GHz
- Suppressed SSID:** off (checkbox)
- Station Separation:** off (checkbox)
- Security:** WPA-PSK Mixed (dropdown)
- Passphrase:** [masked with dots] and a 'Show' button
- Enable Packed Zone:** off (checkbox) and **Zone ID:** 1 (dropdown)

1. The Wizard will ask you how many SSIDs you would like to configure. You can configure up to 18 SSIDs (8 on the 2.4 GHz and 8 on the 5 GHz, in addition to a guest SSID for each band).
2. Once you have selected the number of SSIDs you wish to use, you will be able to configure them individually.
3. Bandsteering moves 5 GHz-compatible client devices to that frequency. This is beneficial when you have devices that operate on an older wireless standard, such as wireless G or B. You can keep slower devices on the 2.4 GHz band and move the faster clients onto the 5 GHz band.

Once you enable band steering under the 2.4 GHz band, you need to make sure all the 2.4 GHz settings match the 5 GHz settings. The best way to do this is to make all your changes under the 2.4 and click **Save and Continue to 5 GHz**. This will copy your 2.4 GHz settings over to the 5 GHz, including any guest network settings you may have configured. Once you are done making the changes, click **Save**, then **Save and Apply** to apply your changes.

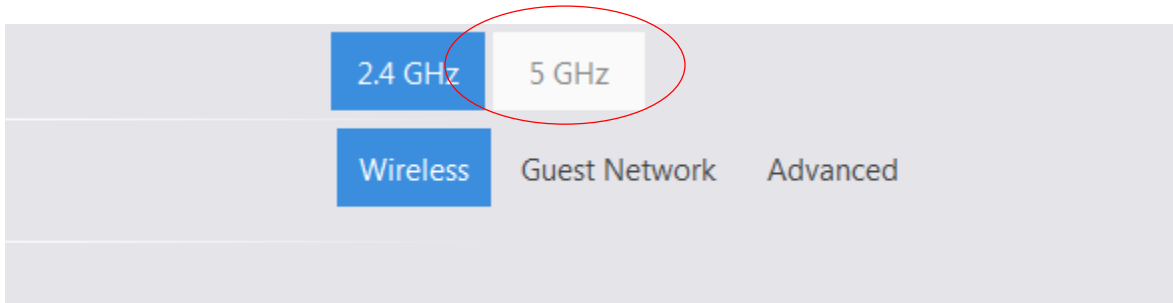

## Save Changes

There were changes detected. Do you want to save before leaving?

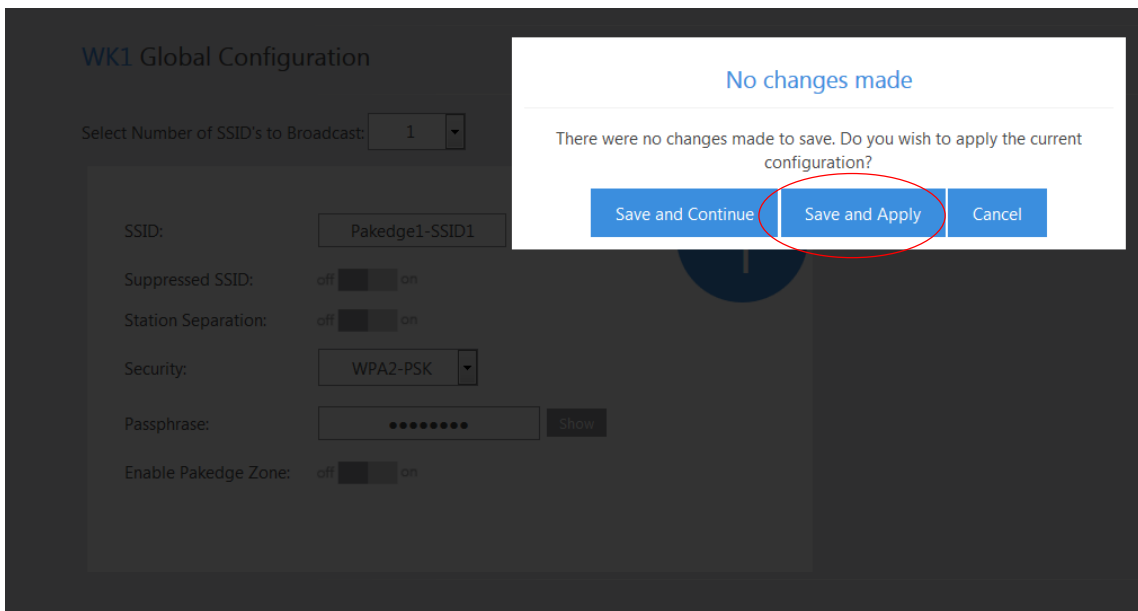
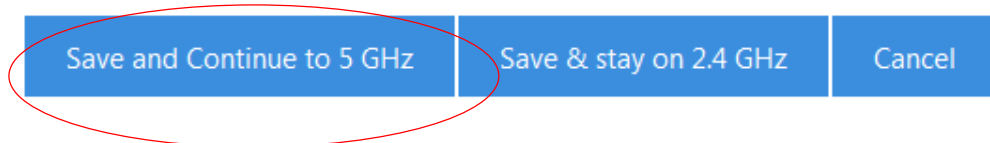

4. If you do not enable bandsteering, please make sure that you use different SSID names for your 2.4G and 5G wireless. Without bandsteering enabled, you cannot have an SSID on the 2.4 with the same exact settings as an SSID on the 5 GHz.
5. Once you have selected the number of SSIDs you want, you can configure the SSID name, security, password, etc.
6. Enable **Pakedge Zone**(WK/WX version only), the Pakedge pre-configured VLAN settings, to optimize your network performance.

# Advanced Settings in Global Configuration

Under the Advanced tab you will encounter two options.

- **802.11 Mode:** This will allow you to set the mode of the access points. By default, it is set to B/G/N. This means that any wireless devices that support these modes will be allowed to connect. You can set the mode to any of the following choices:
  - For 2.4 GHz
    - G/N (Default)
    - B/G/N
    - B/G
    - N
    - G
    - B
  - For 5 GHz
    - A/AC/N-Mixed
    - AC/N-Mixed
    - AC Only
    - N/A-Mixed
    - A-Only
    - N-Only
- **Channel mode:** This option will allow you to set the channel width of your access points. When set to 40 MHz, the access points will be allowed to use more channels to increase throughput (speeds). Although this can be beneficial, it can also cause issues. If you are in a populated area, using more channels will increase the chances of encountering interference. A 20 MHz channel mode is recommended for areas with many nearby access points. For the 5 GHz band, you have the option to select 20, 40, or 80. Please note the 80 is only available when the AP is in AC mode.

## Guest network (optional)

1. The Guest Network is designed for routers that do NOT support VLANs. The Guest Network acts as its own network with no communication to other SSIDs.
2. To enable and set the security settings on the guest SSID, click on the guest network option towards the upper right hand side.
3. Here you can change the SSID and password of the guest network.
4. After making your changes under the Guest Network, click on the **Wireless** tab to save and apply your changes.

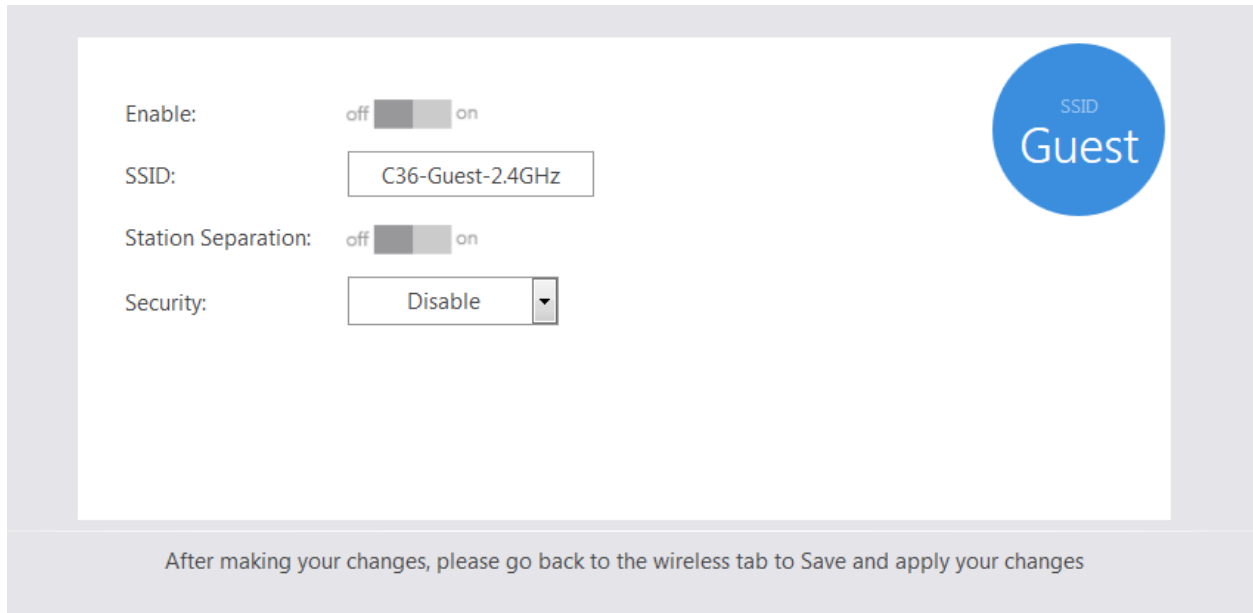

- Applying Changes will push the configuration to the access points. Once the NK-1 controller is done applying the configuration to the access points, you will be redirected to the **Access Point** page. You can click **User Manual** to see the status of the access points.

Dashboard Settings Dealer Tools Wizard Uptime: 17m

Manual Setup LED Controls AP

Manage / Unmanage Re-Scan Factory Default Set IP Configure

AP Location	Type/Serial	Model	IP	Operating Mode	Channel	MAC Address	Power	License	Status	
Click to edit	Type: Indoor S/N: WK-1T0415A10634	WK-1	192.168.1.128	Access Point	2.4 1	90:a7:c1:08:07:c6	2.4 Max dBm		Online	<input type="checkbox"/>
Click to edit	Type: Indoor S/N: WK-1T0415A11087	WK-1	192.168.1.129	Access Point	2.4 1	90:a7:c1:08:11:fa	2.4 Max dBm		Online	<input type="checkbox"/>

## Dashboard

The dashboard will display connected access points at the top.

# Dashboard & Widgets

You can click on the Widgets button towards the upper-right hand side to display all of the widgets on the NK-1 controller.



The widgets display important information about the NK-1 controller.

- **CPU Consumption:** Measures how much of the NK-1 controller's CPU is being used. For best performance, keep it below 65%.
- **Memory Consumption:** Measures the NK-1 controller memory usage. For best performance, keep it below 60%.



- AP Health Status: Displays Online, Unhealthy, and Offline APs.
  - Online AP: APs are configured and online.
  - Unhealthy AP: APs either:
    - Do not have the correct configuration.
    - Are unmanaged by the controller and therefore cannot be configured
  - Offline AP: The NK-1 controller cannot find the APs. APs with default IP addresses at 192.168.1.250 will also be listed under this section.

You can also click on the graph to get more details about which APs are online/offline/unhealthy.

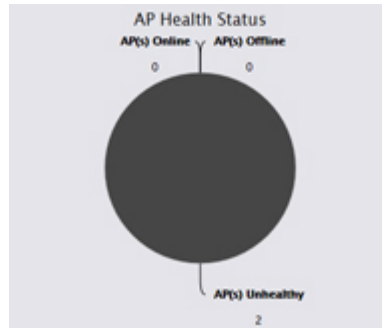

**Clients per AP:** This widget will show you all the clients connected to your APs. You will see a bar graph that lists the number of devices per AP. You can click on this bar to get more information about the connected device, its MAC address, and signal strength.

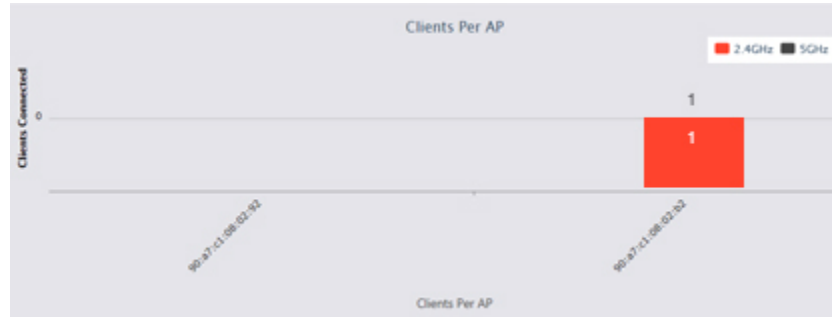

**MAC filter and WiFi schedule:** This section will display any current WiFi schedules or MAC filter policies.

## Reports

The Reports page gives you summarized and detailed information about your access points and the connected clients. In addition, this section provides logs, when APs go offline/online, and whenever the global configuration is updated.



Reports has 5 sections:

## Summary

Provides basic information about your access points, like MAC address, AP model, AP mode (B/G/N), wireless channel, AP firmware version, IP address of the AP, and the default gateway. If you prefer to not see the MAC address of the AP under Device, you can change the location name under Settings – Access Point.

The screenshot shows the 'Summary' report table. At the top right, there are tabs for Summary, Detailed, Custom, Client List, Client History, and Events. Below the tabs, there is a 'Last Updated: 15:28:35 08/03/2015' timestamp and a 'Refresh' button. The table has the following columns: Device, Model, Mode, Channel, Firmware, IP, and Gateway.

Device	Model	Mode	Channel	Firmware	IP	Gateway
90a7c108003c	WK1	N/G	6	1.08	192.168.1.114	192.168.1.99
90a7c108003c	WK1	A/N/AC	36	1.08	192.168.1.114	192.168.1.99
90a7c10801e2	WK1	N/G	2	1.08	192.168.1.117	192.168.1.99
90a7c10801e2	WK1	A/N/AC	36	1.08	192.168.1.117	192.168.1.99

## Detailed

Provides additional information about your access points and the clients connected to them. You will also see a list of SSIDs, the VLAN of each SSID, the security settings of each SSID, and the number of clients connected to each AP. You can click on the number of clients connected to see a list of the devices with their MAC addresses and the signal strength.

## Custom

Allows you to create your own reports with the information in the order you prefer. Click **Create** to create a report.

1. Select the APs you want to monitor from the Available AP section. The order in which the APs are displayed under Monitored AP will be the same on the custom report.

2. Select the data you want to view from the Available Data section. The order in which the fields are listed will be the same in the custom report.
3. Name the report in the **Save As** field and click **Apply**.
4. The new custom report will now be available just to the right of Detailed.

Client	Date	Time	AP MAC Address
AP in office	Apr 28, 2015	09:42 AM	90a7c108003c
AP in office	Apr 28, 2015	09:42 AM	90a7c108003c
AP in office	Apr 28, 2015	09:37 AM	90a7c108003c
AP in office	Apr 28, 2015	09:37 AM	90a7c108003c
AP in office	Apr 28, 2015	09:32 AM	90a7c108003c
AP in office	Apr 28, 2015	09:32 AM	90a7c108003c
AP in office	Apr 28, 2015	09:32 AM	90a7c108003c
AP in office	Apr 28, 2015	09:27 AM	90a7c108003c
AP in office	Apr 28, 2015	09:27 AM	90a7c108003c
AP in office	Apr 28, 2015	09:22 AM	90a7c108003c
AP in office	Apr 28, 2015	09:22 AM	90a7c108003c
AP in office	Apr 28, 2015	09:18 AM	90a7c108003c
AP in office	Apr 28, 2015	09:18 AM	90a7c108003c
AP in office	Apr 28, 2015	09:13 AM	90a7c108003c
AP in office	Apr 28, 2015	09:13 AM	90a7c108003c
AP in office	Apr 28, 2015	09:11 AM	90a7c108003c
AP in office	Apr 28, 2015	09:11 AM	90a7c108003c
AP in office	Apr 28, 2015	09:06 AM	90a7c108003c
AP in office	Apr 28, 2015	09:06 AM	90a7c108003c
AP in office	Apr 28, 2015	09:02 AM	90a7c108003c
AP in office	Apr 28, 2015	09:02 AM	90a7c108003c
AP in office	Apr 28, 2015	08:55 AM	90a7c108003c
AP in office	Apr 28, 2015	08:55 AM	90a7c108003c

**Edit/Delete a Custom Report:** If you need to edit or delete a custom report, select Custom under Reports and choose the custom report you need to edit/delete from the drop down box. After hitting Edit, you can make adjustments to the custom report and select Update. If you want to completely remove the report, click Remove.

## Client list

The client list displays all of the devices connected wirelessly.

Client MAC Address	Client IP Address	Client Name	Client Vendor	AP MAC Address	AP Band
d4:14:6f:21:e4:a0		d4:14:6f:21:e4:a0	Apple	90a7c108003c	5Ghz

Showing 1 to 1 of 1 entries

## Client History

Client history shows a list of the clients and indicates the time those clients moved from one AP to another or one band to another.

Select Client to view History

4c7c5f2d208e 6c4008710b11 789f7088fc15 90b686202d7b 9cd9171e01cb d4446f21e4a0

Show 10 entries Search:

Client MAC Address	AP Model	AP Band	AP MAC Address	AP Location	Date/Time	Client Name
d4446f21e4a0	WK1	5	90a7c10801e2		Jul 23, 2015 01:54pm	
d4446f21e4a0	WK1	2.4	90a7c108003c		Jul 23, 2015 06:34pm	
d4446f21e4a0	WK1	5	90a7c10801e2		Jul 23, 2015 06:34pm	
d4446f21e4a0	WK1	2.4	90a7c108003c		Jul 23, 2015 06:39pm	
d4446f21e4a0	WK1	5	90a7c10801e2		Jul 27, 2015 11:10am	
d4446f21e4a0	WK1	5	90a7c108003c		Jul 27, 2015 11:16am	
d4446f21e4a0	WK1	5	90a7c10801e2		Jul 27, 2015 07:24pm	
d4446f21e4a0	WK1	5	90a7c108003c		Jul 29, 2015 10:03am	
d4446f21e4a0	WK1	5	90a7c10801e2		Jul 29, 2015 02:01pm	
d4446f21e4a0	WK1	5	90a7c108003c		Jul 29, 2015 02:06pm	

Showing 1 to 10 of 22 entries

## Events

The Events tab displays when global configurations are updated, as well as when an AP goes offline or come back online. The date, time and AP affected are recorded as well.

Dashboard Settings Master Tools Events

Summary Detailed Custom Events

Show 10 entries Search:

Event	Date	Time	AP Location
AP is offline	Apr 28, 2015	0942 AM	WUFC010004
AP is offline	Apr 28, 2015	0942 AM	WUFC010004
AP is offline	Apr 28, 2015	0937 AM	WUFC010004
AP is offline	Apr 28, 2015	0937 AM	WUFC010004
AP is offline	Apr 28, 2015	0932 AM	WUFC010004
AP is offline	Apr 28, 2015	0932 AM	WUFC010004
AP is offline	Apr 28, 2015	0927 AM	WUFC010004
AP is offline	Apr 28, 2015	0927 AM	WUFC010004
AP is offline	Apr 28, 2015	0922 AM	WUFC010004
AP is offline	Apr 28, 2015	0922 AM	WUFC010004
AP is offline	Apr 28, 2015	0918 AM	WUFC010004
AP is offline	Apr 28, 2015	0918 AM	WUFC010004
AP is offline	Apr 28, 2015	0913 AM	WUFC010004
AP is offline	Apr 28, 2015	0913 AM	WUFC010004
AP is offline	Apr 28, 2015	0908 AM	WUFC010004
AP is offline	Apr 28, 2015	0908 AM	WUFC010004
AP is offline	Apr 28, 2015	0903 AM	WUFC010004
AP is offline	Apr 28, 2015	0903 AM	WUFC010004
AP is offline	Apr 28, 2015	0858 AM	WUFC010004
AP is offline	Apr 28, 2015	0858 AM	WUFC010004

## Settings

### Macrocell Controller

The Macrocell Controller option has 7 sections to it. Here you will be able to perform functions such as changing the password to the controller, resetting the controller, updating firmware, and much more.

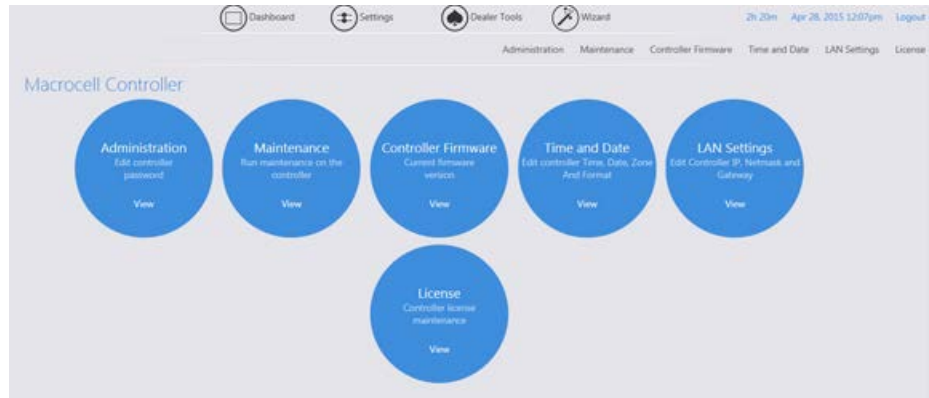

## Administration

Here you can change the default password by clicking **Change Password**.

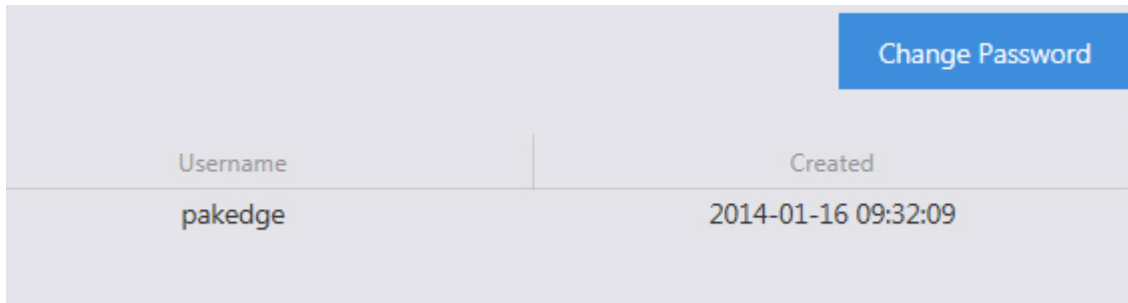

## Maintenance

Here you can perform several functions. Each function is covered in the next section.

- **Backup Configuration:** The NK-1 controller allows you to back up configurations you made to the controller if you ever need to factory default the NK-1 controller. These changes include the global configurations, IP addresses, and host names.
- **Restore Configuration:** Allows you to restore your saved configuration page.
- **Factory Default Controller:** The controller and the AP will reset to default settings.
- **Reboot Controller:** If needed, you can reboot the controller.

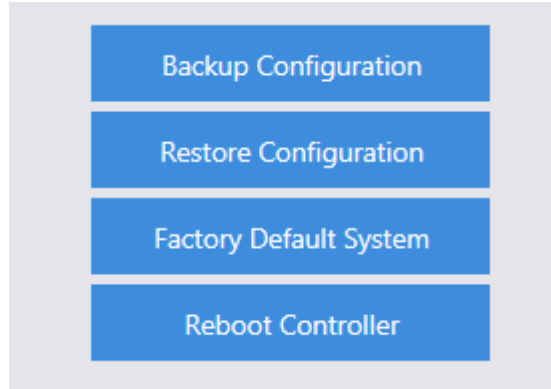

## Controller Firmware

If you have a new firmware, you can upload the file manually or download the latest from the cloud and then apply it to your controller.

Current Controller Firmware:

3.17-1

Latest Available Controller Firmware:

Update Controller Firmware:

Download From Cloud

Upload

## Time and Date

In this section, you can set the time, date, country, and whether you want the time displayed in a 12 or 24 hour format.

Time and Date

Set Time and Date Automatically

Date and Time: 08/03/2015 03:31 pm

Time Zone (GMT-08:00) Pacific Time (US & Canada)

Country United States

Time Format 12 hour

Apply

## LAN Settings

Change the IP address, subnet mask and gateway of the NK-1 controller.

LAN Settings

IP: 192.168.1.240

Netmask: 255.255.255.0



Gateway: 192.168.1.99

Hostname: PakedgeNK-1

Save

## License

This section displays each access point and its license status. If you are getting a red thumbs down, verify that you have enough licenses for all the access points, that the firmware is up-to-date on each AP, and that they are being managed by the NK-1 controller.

License Information				
Your License allows up to				1 Ap(s) Found
INTERNAL USE				1 AP(s) 
				0 AP(s) 
Location	Model	IP	MAC Address	License
	WK1	192.168.1.114	90:a7:c1:08:00:3c	

## Access Point

The access point section will show you how to manually configure and reboot access points. This section also shows you how to adjust the LED lights of your access points.



## Manual setup

You can configure your access points manually under the Manual Setup page if you decide not to use the Wizard. You would also use this section if you add an additional access point without rerunning the Wizard. Below is a detailed explanation of all the options under the AP Settings page.

**AP Location:** You can edit and rename this field for a better understanding of the access point's physical location (for example, Upstairs Bedroom).

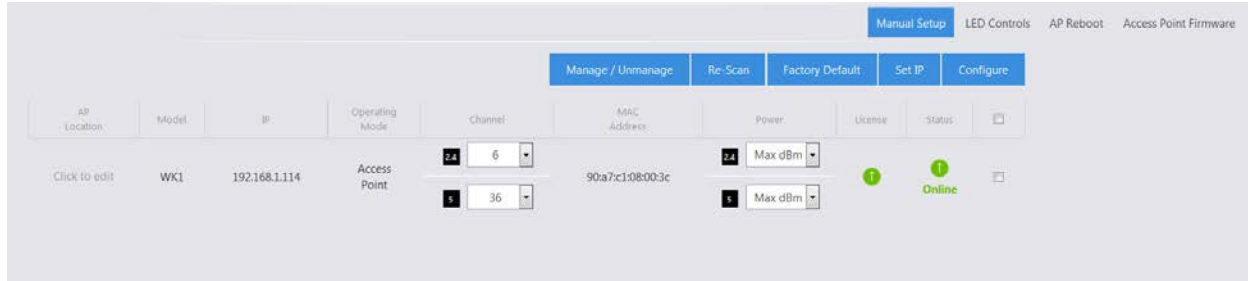

**Remove:** If you removed an access point from your setup and don't want it to stay listed in the AP table, select it and click Remove.

**Manage/Unmanage:** This option allows you to toggle an access point between managed and unmanaged. If you want to make an AP a standalone device again that is no longer managed by the NK-1 controller, here is where you can do so.

**Re-Scan:** Scans for changes like new access points and Status.

**Factory Default:** If you are having any problems configuring the APs, you can always set them back to factory default.

**Set IP:** By default, all the IPs will have the same address of 192.168.1.250. Part of the configuration process is to change the IP addresses of all the APs. You can choose to change the IP using DHCP or set a static IP address.

**Configure:** This will apply the global configuration to the selected AP(s).

You can change the channel and transmit power under the Channel and Power options. Make sure you click  after making the changes.

## LED Controls

The NK-1 controller is able to configure LEDs on your access points. Click the On/Off switch to change the power status of your WK-1/WX-1 LEDs.

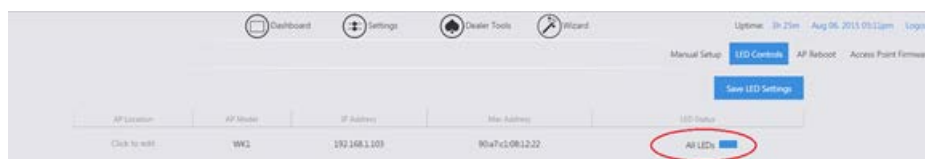

## AP Reboot

The AP reboot section will allow you to either individually reboot an access point or multiple access points at once. To reboot an access point, simply click on the checkbox next to an access point.

Only managed APs will be available to Reboot

AP Location	AP Model	IP Address	Mac Address	Status	<input type="checkbox"/>
	WK1	192.168.1.114	90:a7:c1:08:00:3c	<span style="color: green;">!</span>	<input type="checkbox"/>

[Reboot](#)

## Access Point Firmware

The AP firmware can be upgraded from the cloud. The controller always checks for the latest AP firmware on the cloud and compares it against the firmware running on your AP. If you have an outdated firmware, the controller will give you the option to update to the latest version.

AP Location	IP	Model	Active Firmware	Status	<input type="checkbox"/>
	192.168.1.114	WK1	1.08	<span style="color: green;">!</span>	<input type="checkbox"/>

[Re-Scan](#)   [Update AP Firmware From Cloud](#)  
 Latest Firmware Version: 1.05

**Re-Scan:** after updating the firmware, you can do another scan to detect the new firmware on the AP(s) and verify they are all on the correct version.

## Adding an Additional Access Point

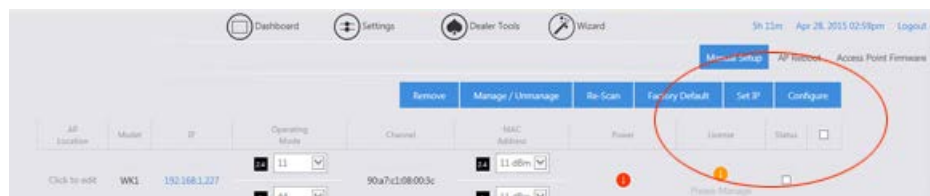

Below are the steps for adding an additional AP to an existing system:

1. If you are adding a new AP out of the box, the default IP address should be 192.168.1.250. The Status will blink Set IP. Select the checkbox next to it and select **Set IP**.



2. After setting a static IP or letting the access point obtain one from the DHCP (recommended), the NK-1 controller will check the new access point's firmware to see if it matches the firmware of the existing units. If the firmware is out-of-date, you will need to go to the Access Point Firmware section to update the firmware on the AP.
3. When the firmware on all access points match, the status will display Please Manage. To do so, check the box for the AP and select **Manage/Unmanage**.



4. Now that the access point is managed, you will see that it needs to be configured. Again, select the access point and click Configure . The NK-1 controller will now push the global configuration to the new AP.
5. Once finished, the access point will display as online .

## Global Configuration

The settings for the Global Configuration section have already been discussed earlier in this manual, in the section The Wizard Step 3: Global Configuration. If you decide to make any changes to your SSIDs or enable/disable the guest network, you can always refer back to the Global Configuration page, make the necessary changes, and apply the configuration to the APs.

### WK Global Configuration

Select Number of SSID's to Broadcast:  Enable Band Steering:

SSID:

Suppressed SSID:  off  on

Station Separation:  off  on

Security:

Passphrase:

Enable Packedge Zone:  off  on Zone ID:

1

SSID

# Advanced

## MAC Filtering

MAC filtering allows you to block certain devices from connecting to your wireless network. To block a device, go to **Settings > Advanced > MAC Filtering**. Click on **Add**. Under Device Name, give it a name to distinguish it and enter the device's MAC address. You will then see a list of access points on the network and pick which AP and even which band (2.4 GHz or 5 GHz) you want to block the device from. After making the necessary changes, click **Save**. You will be redirected to the main MAC Filtering page. The main MAC filtering page allows you to edit the entry created, remove it or just apply the changes. Please note that your MAC filtering changes will not be activated until you hit **Apply**.

**Add MAC Filter**

Device Name

John's iPhone

Device MAC Address

d4:12:43:45:43:12

**Select the AP(s) and band you would like to block this device from**

Show 10 entries

Search:

Location	MAC	Model	Band	Choose All
	90:a7:c1:b8:01:00	WX1	2.4 5	<input type="checkbox"/> <input type="checkbox"/>

Showing 1 to 1 of 1 entries

Save

Cancel

Client Name	MAC Address	AP's Effected	
John's iPhone	d4:12:43:45:43:12	90a7c1b801:00   WX1	<div style="display: flex; justify-content: space-between; gap: 5px;"> <span>Add</span> <span>Remove</span> <span>Edit</span> <span>Apply</span> </div> <div style="display: flex; justify-content: space-between; gap: 5px; font-size: small;"> <span>Select All Devices</span> <span><input type="checkbox"/></span> </div>

## Client Limit

In some cases you may want to set a limit on how many devices can connect to your AP. This is useful when you have multiple APs and plenty of coverage, but somehow the devices decide to stick to one AP instead of spreading out to multiple ones. You can limit the number of client devices by going under **Settings > Advanced > Client Limit**. By default, the client limit is disabled and set to unlimited. If you want to enable it, first make sure your AP is managed and configured. Then go to **Status** and click on **Unlimited**. You will be allowed to enter a value between 0 and 127 in the box right under **Client Limit**. After you are done making the necessary changes, click **Apply**.

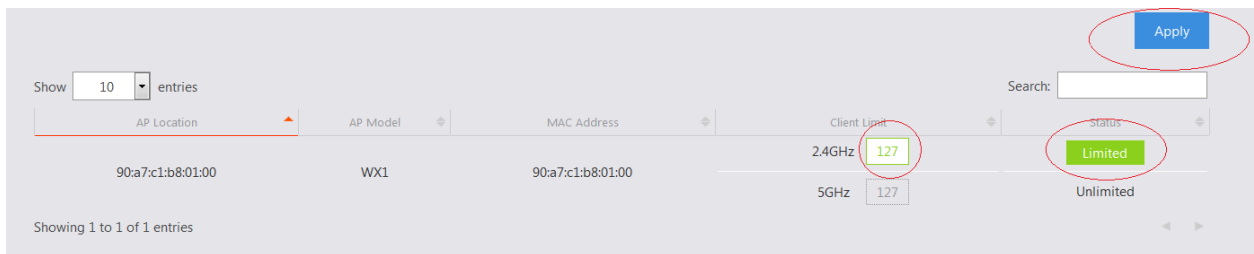

## Scheduling

You can create schedules for each SSID on your network. Creating a schedule for an SSID gives you control over when to enable or disable the broadcast of a specific SSID on the network. As an example, you may want to limit your kids' internet access to certain times and days of the week.

To create a schedule, go to **Settings > Advanced > Scheduling**. Click **Add**, give the schedule a name, and select your desired settings. If you enter a time, please make sure the time is entered in a 24 hour format. Make sure you also select which SSID you want this schedule to apply to. Once you click **Save**, you will be redirected to the main scheduling page where you need to click **Apply** to activate your schedules.

Please note that if you create a schedule that turns off Wi-Fi for an entire day, you will need to wait until midnight for the schedule to take effect.

Schedule Name	Schedule Options	Schedule Time And Date	Included SSID's	Select All Schedules
No Wifi	WiFi Not Available	Tuesday From 13:00 To 17:00	Pakedge-1-24 - WK1 C36-Guest-24GHz - WK1	<input type="checkbox"/>

## Dealer Tools

## Site Survey

Select the targeted access point and click **Site Survey**.



A new window will open and display the site survey utility. The selected access point will scan the frequency for devices currently broadcasting their SSID, and then will display them in the table.



## AP Deployment

The AP Deployment page lets you upload floor plans onto the NK-1 controller and create a heat map for your site to assist with the placement of access points. This will help optimize wireless coverage throughout the property.

To configure AP deployment, follow these steps:

1. Navigate to Dealer Tools and click **AP Deployment**.
2. You will see a page explaining that the controller is scanning for access points. This page will disappear once the scan is over.

## AP Deployment

### A. Scanning for Access Points

The C36 is currently scanning, checking the network for Access Points.

### B. Checking for Existing AP Deployments

The C36 is checking for any existing Deployments you may have.

This panel will automatically close when scanning is complete.

- You will then be presented with the following page. Here you will be able to upload a floor plan onto the NK-1 controller and create the heat map.



- Click on **Upload Floor Plan**.



- Upload your floor plan. Note that you can only upload .jpeg or .png file types.

## Upload Floor Plan

Choose floor plan to upload (File uploaded must be a jpeg or png format)

No file selected.

6. Enter a name for your floor plan and click **Continue**.
7. You will now see your floor plan on the NK-1 controller.

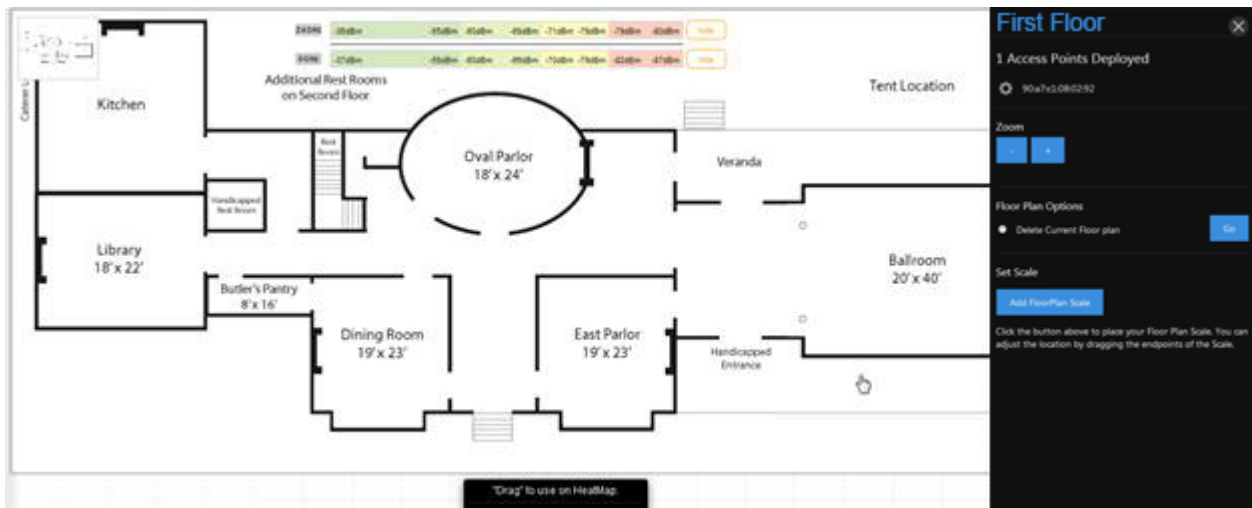

8. Before you can add access points to the heat map, you will need to set a scale. This will tell the NK-1 controller how large the site is and display the proper coverage of an access point. To set the scale, click **Add Floor Plan Scale**.

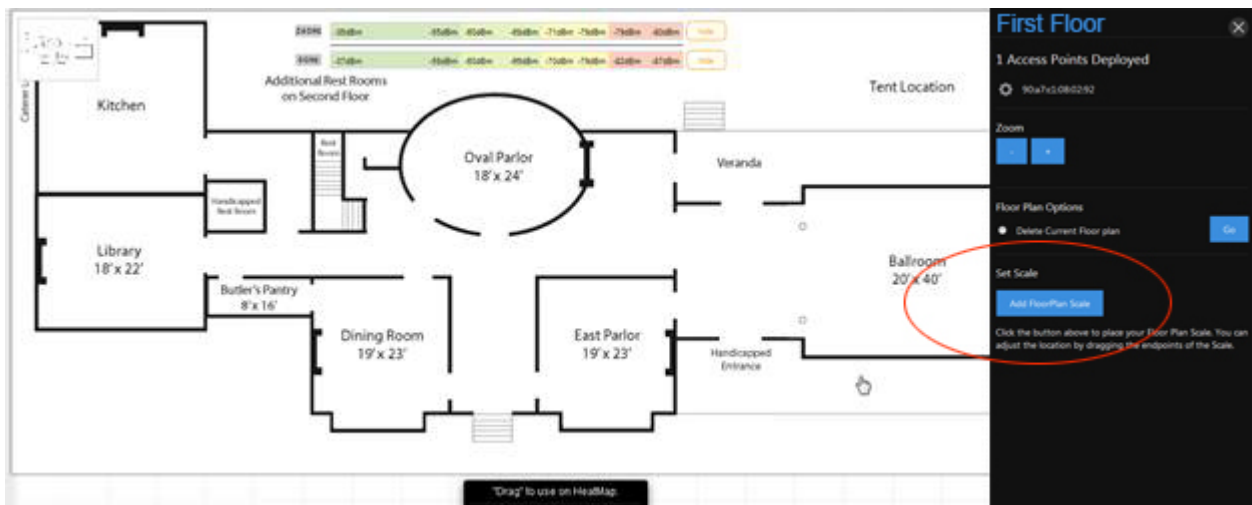

- You will now have a line that you can maneuver as you like. Move the end points to a spot on the floor plan with a known distance.

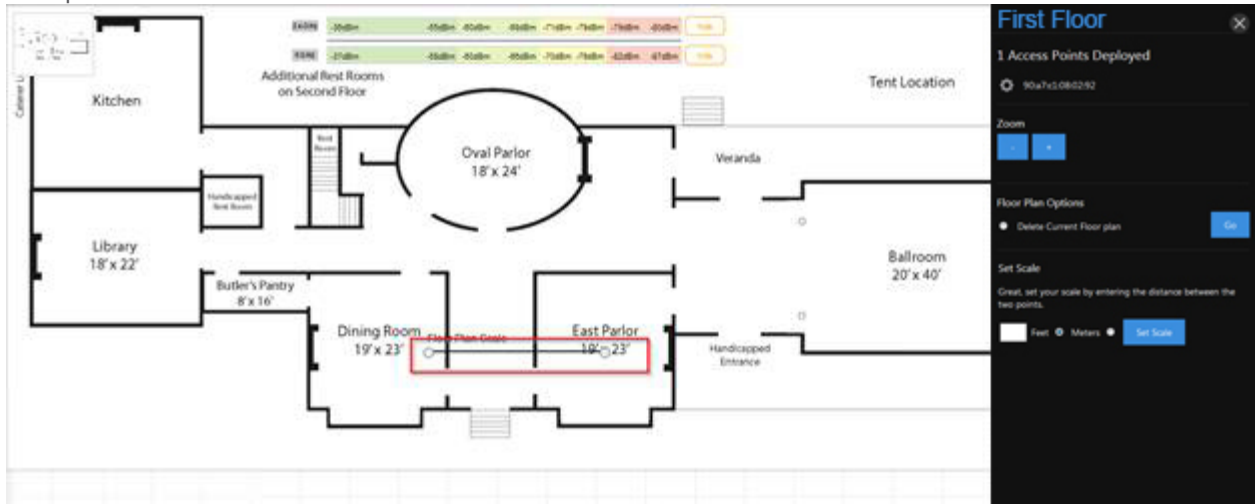

- Enter the distance in either feet or meters. Click **Set Scale**.

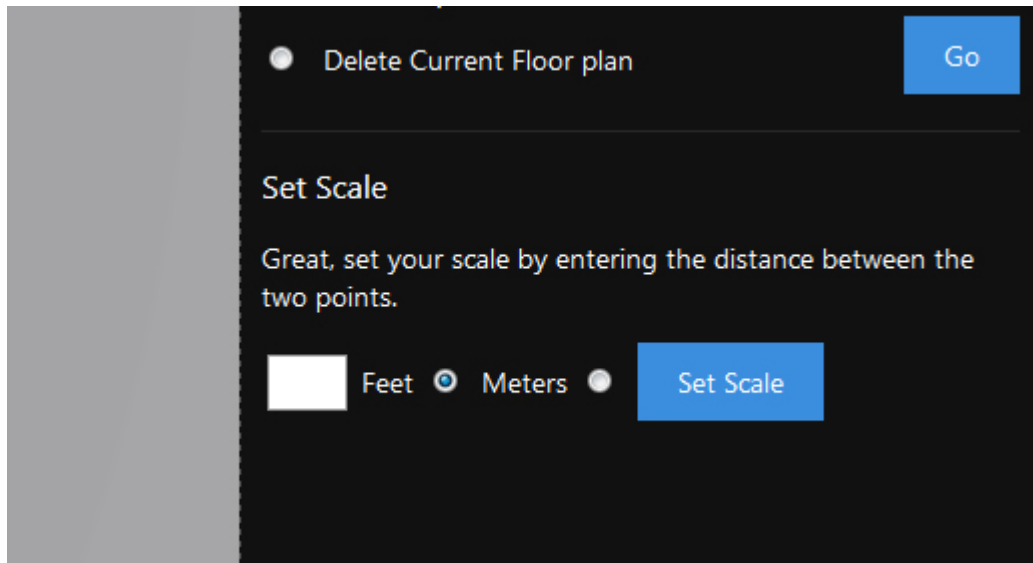

- The scale is now set.

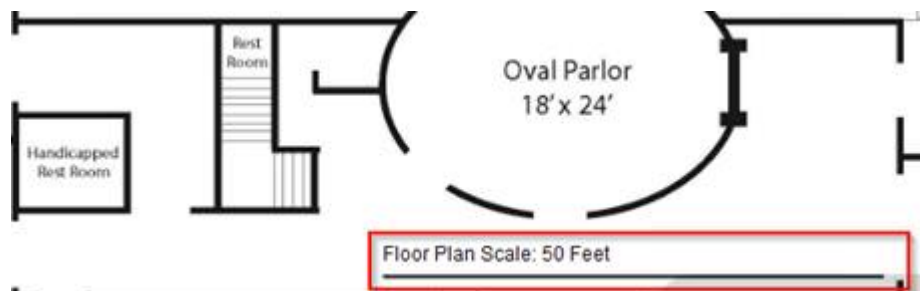

12. With the scale set, you can now close the menu on the right-hand side.

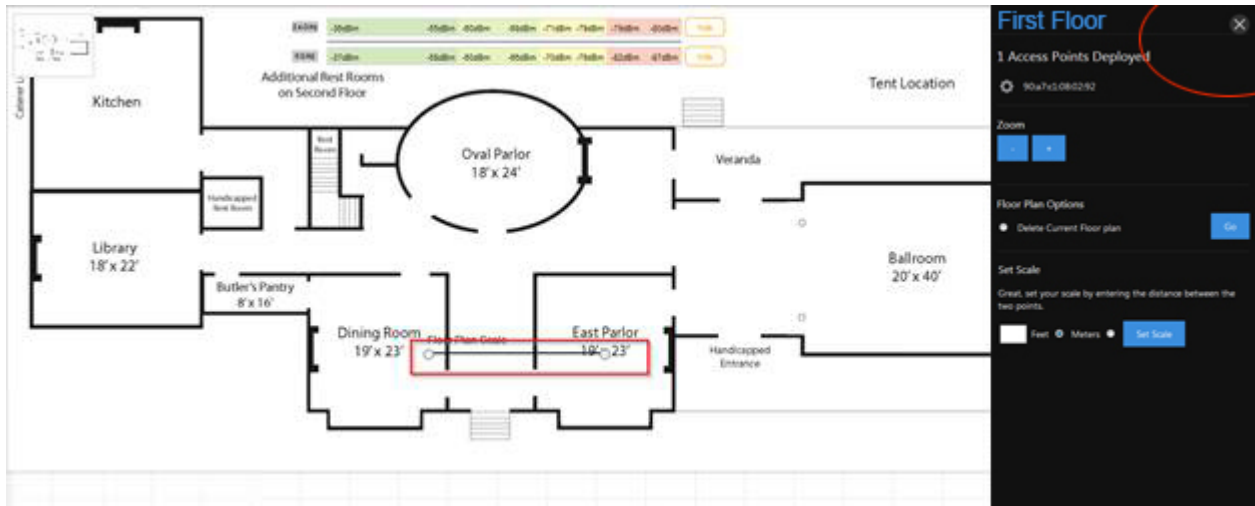

13. Now, we can begin adding access points. Simply drag an access point to the floor plan to view the coverage. You can continue adding access points to the map.

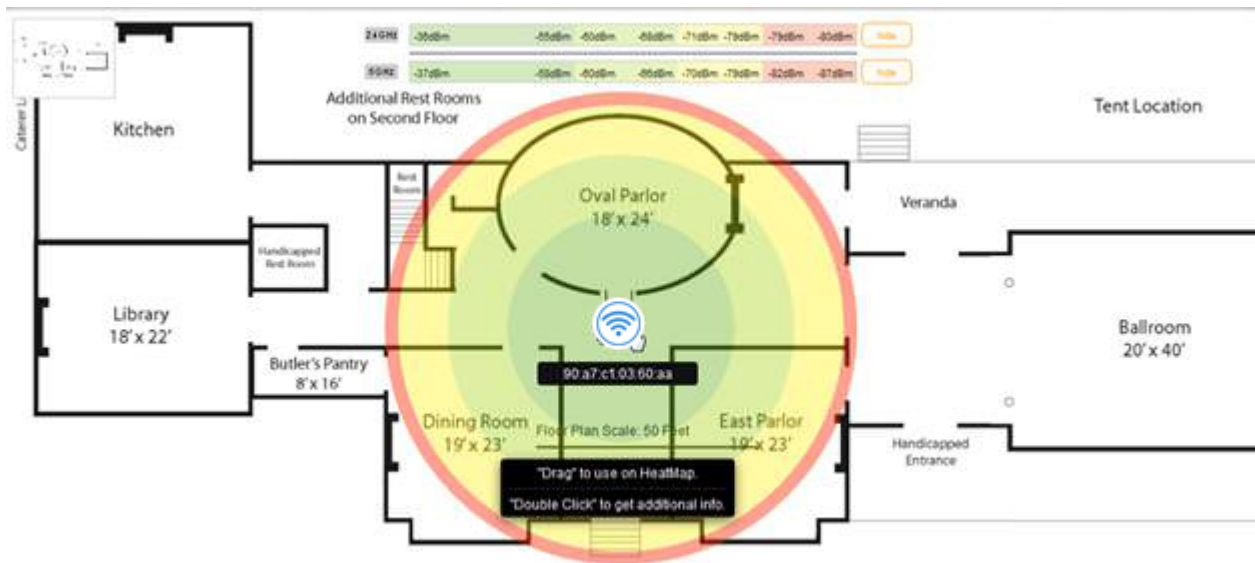



18. From the **Additional Point Details** menu you can change the **Name/Location**, **Channel**, and **Transmit Power** of your individual access points.
19. To change the Name/Location, click on **Edit**.

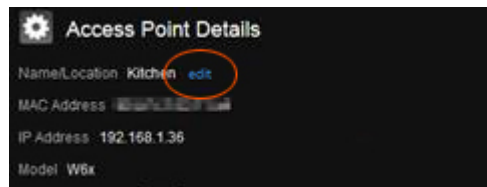

20. The name of an access point is its MAC address by default. To enter a new name, simply click on the textbox and begin typing. Click **Save** once finished.
21. To change the channel of the WAP, click **Edit**.

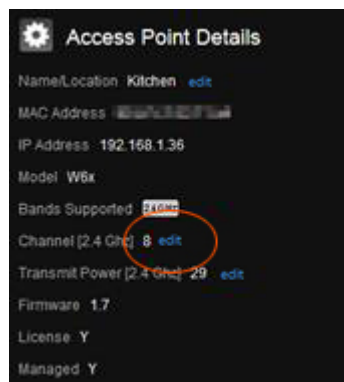

22. Select the channel of the access point. To leave the access point on auto channel, select **Auto**.

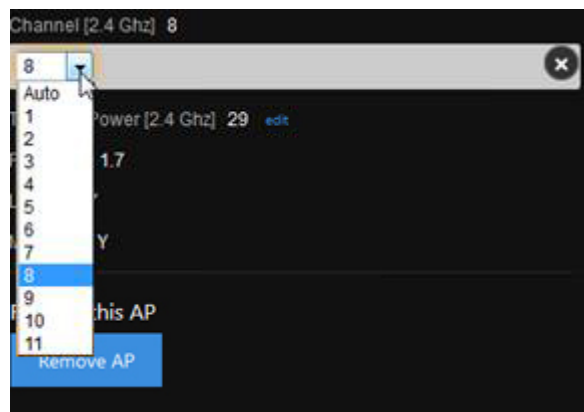

23. If you wish to continue making changes to your heat map, click **Save**. This will save your changes but not apply them—that way, you can finish the configuration of your heat map. If you want to apply the changes to the Global Configuration, click **Save and Apply Changes**.

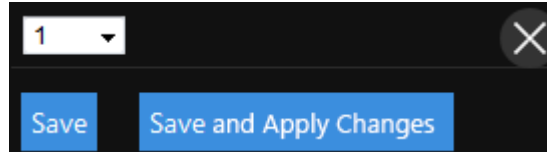

24. Please note that this will cause your access points to update. During that time, the heat map will not be accessible. It is best to finish the configurations on all of your access points before you perform an update.
25. To change the transmit power, click **Edit**.
26. Select the power output you would like to use for the access point. It is set at its maximum output by default.

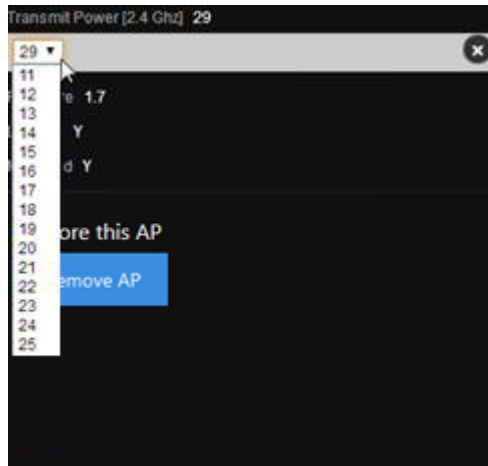

27. Click **Save AP Deployment** once you are finished with your floor plan.

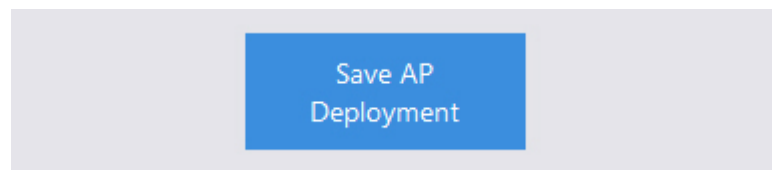

## Wireless Optimization

The NK-1 controller runs some sophisticated intelligence and algorithms to determine the best optimal settings for your network. This can be done manually or automatically in the background, depending on your preference. To optimize your wireless network, find **Dealer Tools** and click **Wireless Optimization**. 4 different optimizations can be used on the NK-1 controller:

## SectorMaxx, TruStream, SmartWav and Fluxx.

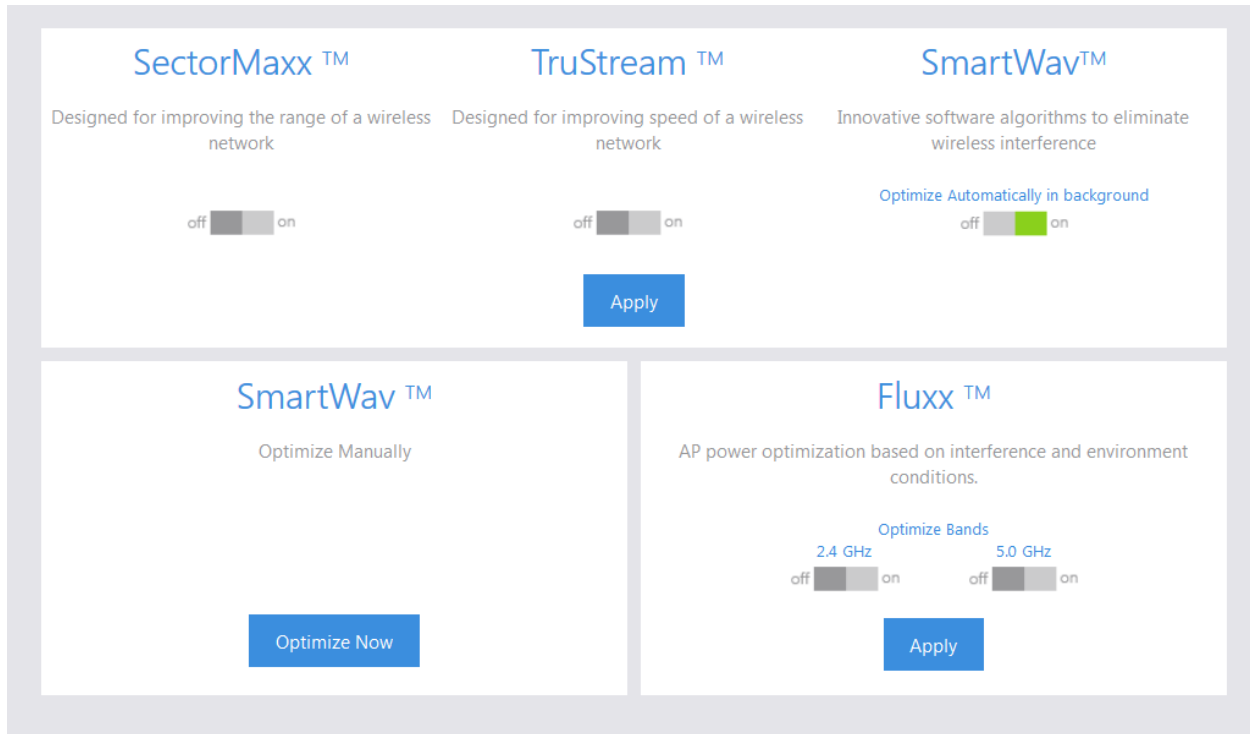

**SmartWav™** technology works in the background to detect any interference from devices on the network that are not controlled by the NK-1 controller. It even goes beyond your own network to look at neighboring networks with access points or devices that interfere with your network. Since you do not have any control over neighboring networks and often even cannot change device settings within your own network, the NK-1 controller implements complex calculations to figure out the best optimal changes for your wireless network. The NK-1 controller will then use these results and apply the optimization and required settings. SmartWav™ runs automatically in the background and gathers information about your network if you enable **Optimize Automatically in Background** as shown above.

This information will be analyzed and the controller will apply these changes at a scheduled default time of every Sunday at 2:00 am. Please note that this scheduled time may be changed by our support personnel only and you can call us at (650) 385-8703 to do so. If you would like to run the optimization manually, click **Optimize**. This will apply the optimized settings to your controller and access points instantly.

Manual optimization can also be run after applying the global configuration to your access points. Once the global configuration is applied to your access points, you will receive a pop up message that says the network has been configured. You will then have the option to run the optimization shown in the figure above.

**SectorMaxx™:** In installations where you do not have enough wireless coverage would rather have more coverage than bandwidth, you can enable SectorMaxx to maximize your wireless range.

**TruStream™:** TruStream does the inverse of SectorMaxx. If you require bandwidth and have enough coverage, you can enable TruStream to maximize your bandwidth.

**Note:** Enabling both SectorMaxx and TruStream will produce results based on your environment. You may get better coverage at certain times during the day and more bandwidth at other times. This setting is only recommended for low-interference environments.

**Fluxx™:** Fluxx helps reduce the power on APs based on interference. Fluxx will detect whether or not your APs are interfering with one another and adjust power levels accordingly.

## Configure the NK-1 Wireless Access Point Controller for W6/W7

If your NK-1 model is the NK-1 Network Cloud Patroller, please skip to the section of Configuring **the NK-1 Network Cloud Patroller**.

The following section is for configuring NK-1 wireless access point controller that is compliance with W6/W7. If your wireless access points are WK/WX series, please skip to the section "Configure the NK-1 Wireless Access Point Controller for WK/WX".

1. In the browser, enter the controller's default IP address of 192.168.1.236 into the Address Bar and press <ENTER>.
2. A web page will appear prompting you for a username and password. Enter **pakedge** for the username and **pakedgen** for the password. Then click "Login" to log into the web administration portal.

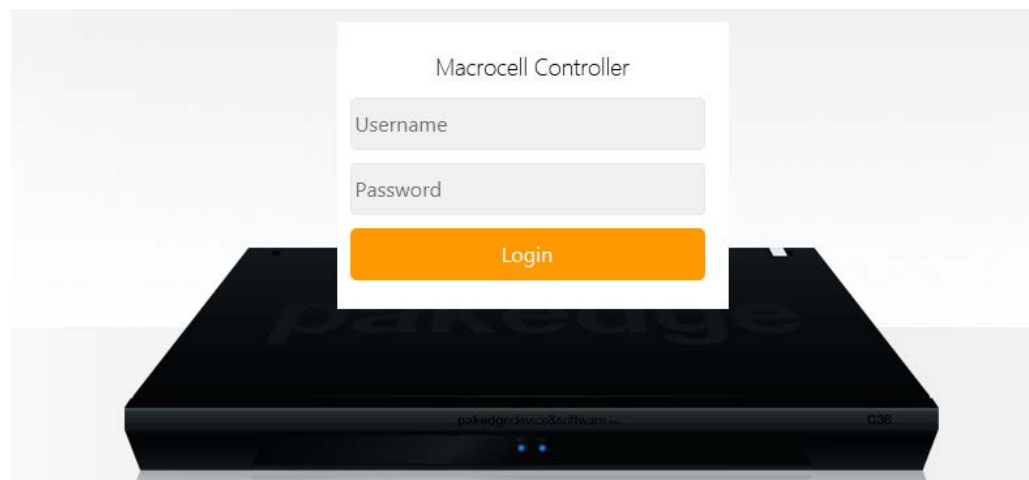

3. Once you have logged into the controller, you will see the Dashboard.

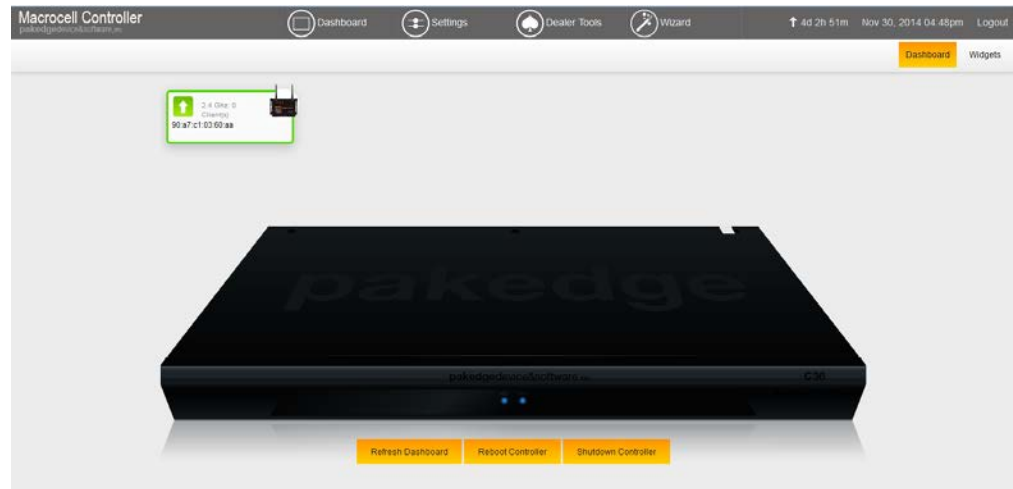

4. Hover your mouse over **Settings** towards the top. Click **Macrocell Controller**.

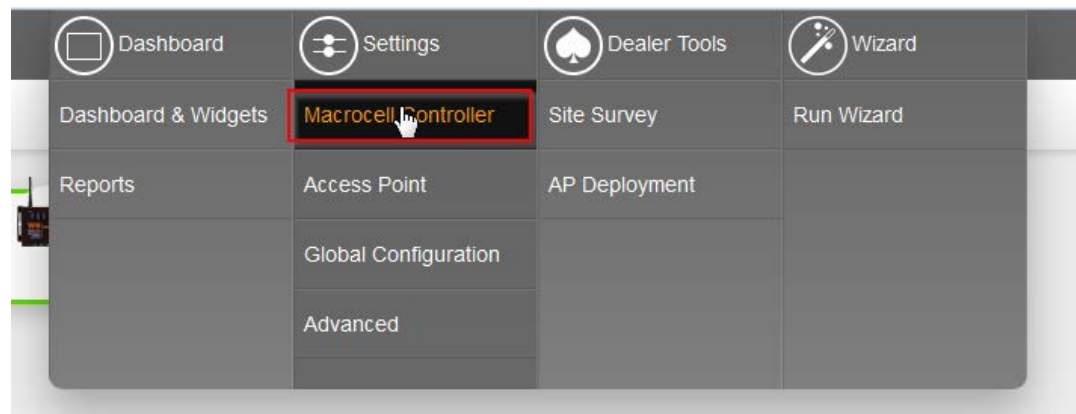

5. Click **LAN Settings**.

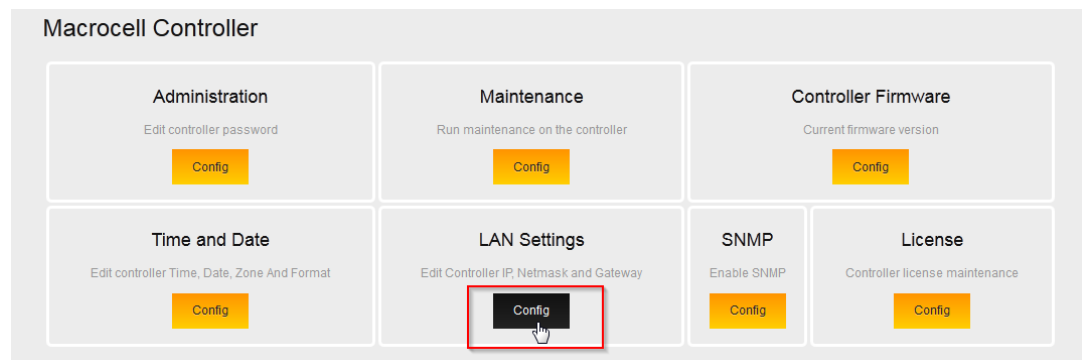

6. Enter the correct default gateway. Click **Save** to finalize the settings. Now that your controller has the correct default gateway you can skip to the section titled **The Wizard**.

LAN SETTINGS	
IP:	<input type="text" value="192.168.50.2"/>
Netmask:	<input type="text" value="255.255.255.0"/>
Gateway:	<input type="text" value="192.168.50.1"/>
Hostname:	<input type="text" value="c36"/>
<input type="button" value="Save"/>	

## The Wizard

The Wizard will discover, manage and configure your access points. Making it a quick and easy tool to get your wireless network up and running.

### Step 1: Firmware

1. Log into the NK-1 controller and hover your mouse over **Wizard** towards the top. Click **Run Wizard**.

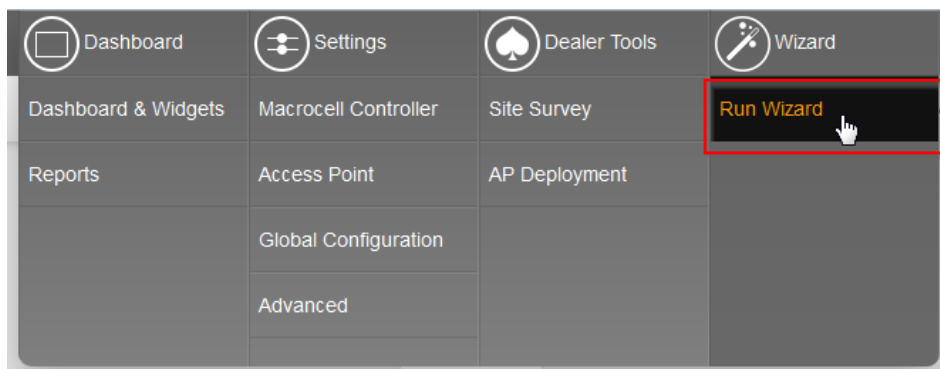

2. Click **start** to begin the wizard setup.



- Before being able to manage or configure the AP(s), they must all be on the same firmware version. If there is any inconsistency in the firmware version, the NK-1 will notify you.

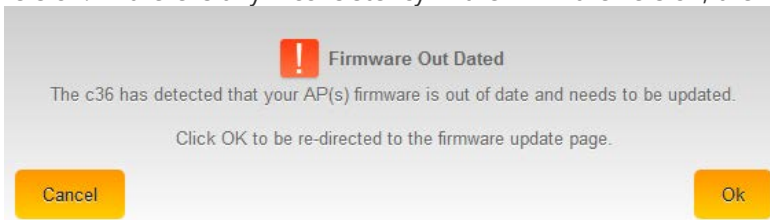

- Click "Ok" and you will be directed to the AP-Firmware update page.
- The icon - indicates which APs have an older firmware as well as the firmware they should be updated to. Select the highlighted APs and click on Update AP Firmware. Once the process is complete, all your APs should display - .

AP Location	IP	Model	Active Firmware	Available Firmware	Status	
	192.168.1.130	WAP-x3G	2.11	2.11		<input type="checkbox"/>
	192.168.1.111	WAP-x3G	2.11	2.11		<input type="checkbox"/>
	192.168.1.110	WAP-x3G	2.11	2.11		<input type="checkbox"/>
	192.168.1.250	W6x	1.2	1.3		<input type="checkbox"/>
	192.168.1.250	W6x	1.2	1.3		<input type="checkbox"/>

- Click "Next" to continue to step 2.

## Step 2: Discover and Manage AP(s)

- Once the firmware has been updated on all access points the NK-1 controller will continue on with the wizard.
- The NK-1 controller will scan your network and discover any compatible access points. Click next to continue.



- The NK-1 controller will detect the DHCP server on the network, which is usually a router. Click

next to continue.

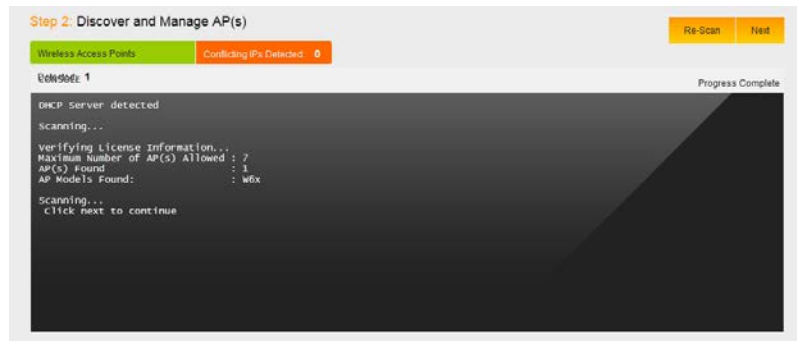

## Step 3: Global Configuration

- In this step you will configure the up to 4 SSIDs as well as an optional guest network.
  - Enable:** Allows you to Enable/Disable an SSID
  - SSID:** Enter the SSID name
  - Suppressed SSID:** When this is set to **"On"**, the SSID will be active but you will not see it broadcasting and will need to manually enter the SSID name to join it
  - Station Separation:** When this is set to **"On"**, devices connected to the same SSID cannot see/ping or communicate with each other
  - Security:** Choose the best security that fits your network needs (Recommended WPA2-PSK)
  - Passphrase:** Enter your wireless password
  - Enable 802.1q tag:** Only Enable when you have a router capable of doing VLANs. When you set it to **"On"** you will be given the option to choice which VLAN to tag it to

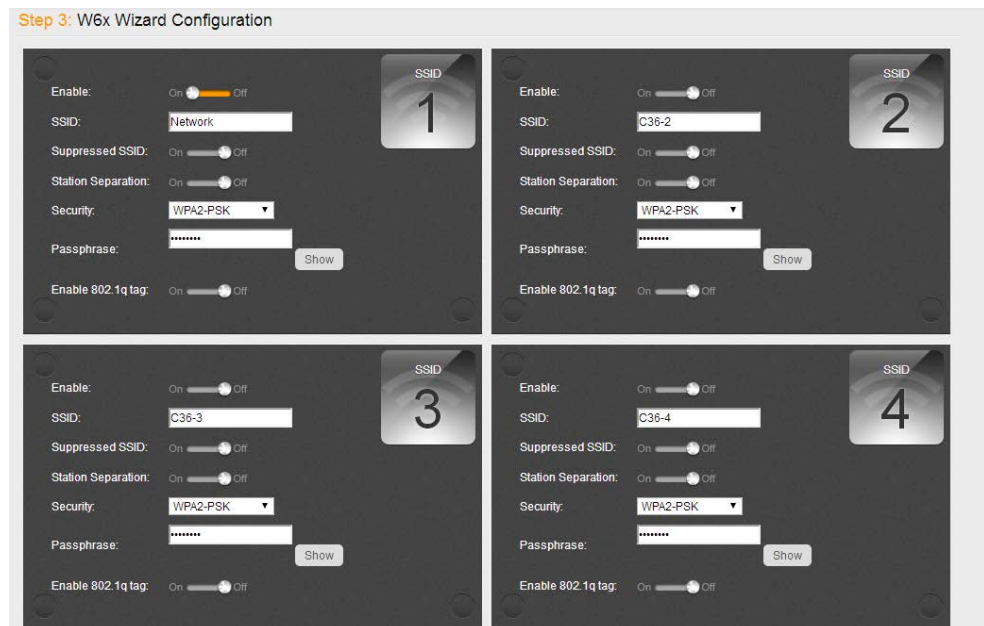

- If you are configuring a W7 access point then the configuration screen will look slightly different. You will be asked by the wizard how many SSIDs you would like to configure. You can configure up to 8 SSIDs on W7's.

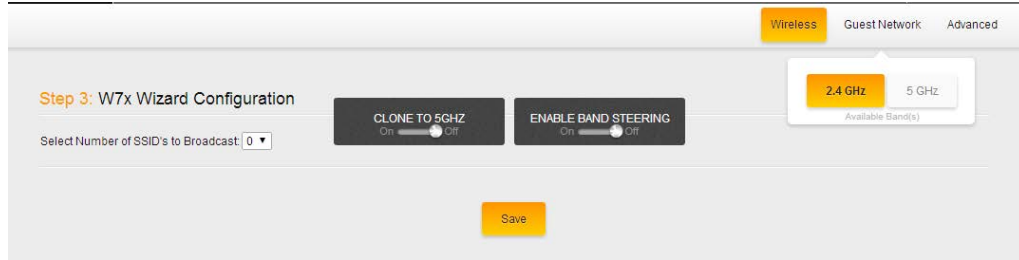

- Once you have selected the number of SSID's you wish to use you will be able to configure the SSID. The SSID options are very similar to the options available if you are configuring the W6.



- For the W7 access points you will have two options at the top that say "Band Steering" and "Clone to 5 GHz". Band Steering allows the access points to influence devices that support 5 GHz to move over to that band instead of staying on the more congested 2.4 GHz band. This can be beneficial when you have devices that operate on an older wireless standard such as wireless G or B. You can keep those slower devices on the 2.4 GHz band and have the faster clients on the 5 GHz band.

In case you might be dealing with a site that has a lot of interference on the 2.4 GHz band, either from neighboring access points or other devices that operate on the 2.4 GHz band, we would recommend keeping the band steering option disabled and then setting the 5 GHz SSID to be different from the 2.4 GHz SSID. This way you can be sure that 5 GHz devices are staying on that SSID.

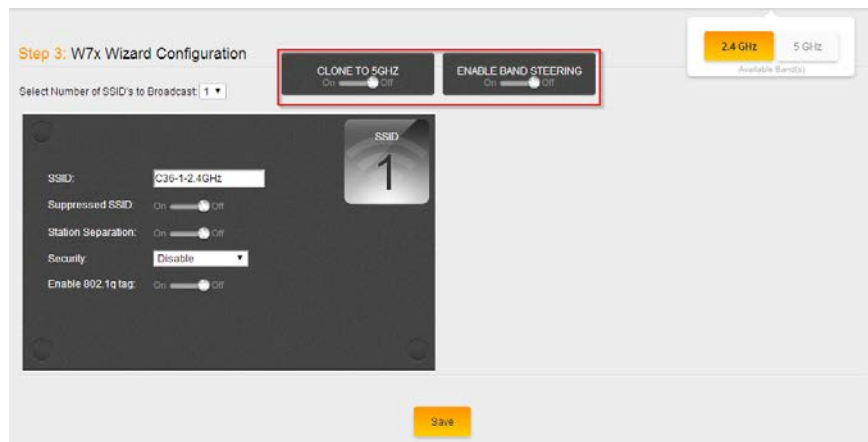

- The Clone to 5 GHz option will allow you to copy the 2.4 GHz SSIDs to the 5 GHz SSID's. This way they will both have identical settings. If you do not wish to have the same SSID's for both the 2.4 GHz and the 5 GHz SSID's you can leave this option disabled and then click on the 5 GHz option towards the upper right hand side.

Step 3: W7x Wizard Configuration

Select Number of SSID's to Broadcast: 0

CLONE TO 5GHz  
On  Off

ENABLE BAND STEERING  
On  Off

Available Band(s): 2.4 GHz 5 GHz

Save

- Here you will see a similar page as to when you configured the 2.4 GHz SSID's. You will be asked how many SSID's you need.

Step 3: W7x Wizard Configuration

Select Number of SSID's to Broadcast: 0

Available Band(s): 2.4 GHz 5 GHz

Save

- Once you have selected the number of SSID's you want you will be able to configure the SSID name, security, password etc.

Step 3: W7x Wizard Configuration

Select Number of SSID's to Broadcast: 1

SSID: C36-1-5GHz

Suppressed SSID: On  Off

Station Separation: On  Off

Security: Disable

Enable 802.1q tag: On  Off

Save

- Once you are done setting up the SSID(s), click "**Save**". You can choose "**Save and Continue**" if you still need to setup the guest network or make any changes under the **Advanced** tab, or "**Apply Configuration**" to write the setup to the access points.

Save Changes

Would you like to Save your changes now?

Cancel Save and stay on 5GHz Apply Configuration

## Advanced settings in global configuration

Under the advanced tab you will have two options.

**802.11 Mode:** This will allow you to set the mode of the access points. By default, it is set to B/G/N. This means that any wireless devices that support these modes will be allowed to connect. You can set the mode to any of the following choices:

- B
- G
- B/G
- N
- B/G/N (default)

**Channel mode:** This option will allow you to set the channel width of your access points. When set to 40 MHz the access points will be allowed to use more channels to increase throughput (speeds). Although this can be beneficial, it can also cause issues. If you are in a populated area, using more channels will increase the chances of encountering interference. Using a 20 MHz channel mode is recommended for areas with many nearby access points.

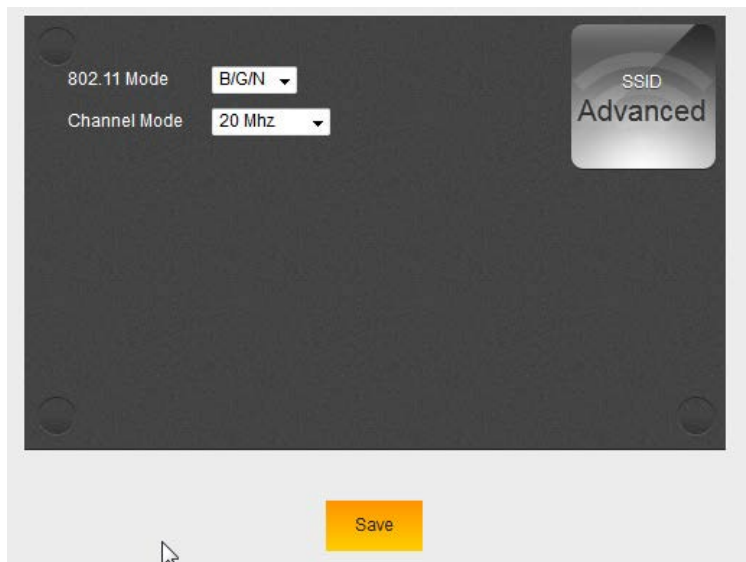

## Guest network (optional)

The Guest Network is designed for routers that do NOT support VLANs. The Guest Network acts as its own network with no communication with the other SSIDs.

1. To enable and set the security settings on the guest SSID click on the guest network option towards the upper right hand side.

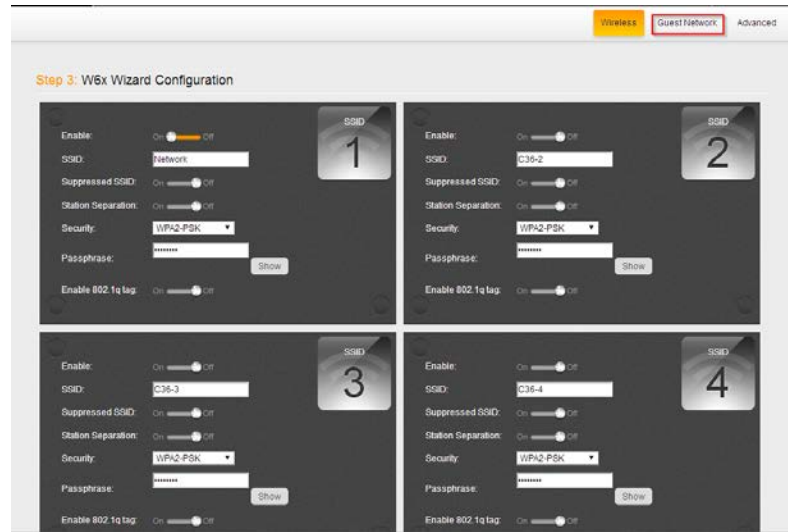

2. Here you will be able to change the SSID and password to the guest network. You can change the subnet that the guest network is on if you wish. The Default Gateway must be set to the IP address of your router. For the DNS you can usually use the same IP as your default gateway or you can use a publicly available DNS server such as 8.8.8.8. Click **“Save”** when done and **“Save and Apply”** to apply the configuration to the APs.

Enable:  On  Off

SSID:

Station Separation:  On  Off

Security:

**Guest Network IP Setup**

IP Address:

IP Subnet Mask:

**Use Guest Network As DHCP Server**

Starting IP Address:

Ending IP Address:

**Gateway and DNS**

Primary DNS:

Secondary DNS:

3. You will see the following message, after a moment the NK-1 controller will redirect you to another page.

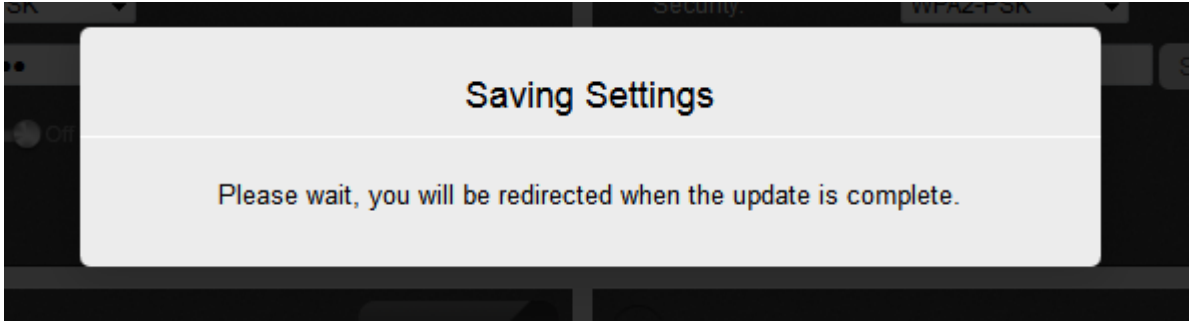

4. Click **Apply Changes** to push the configuration to the access points.

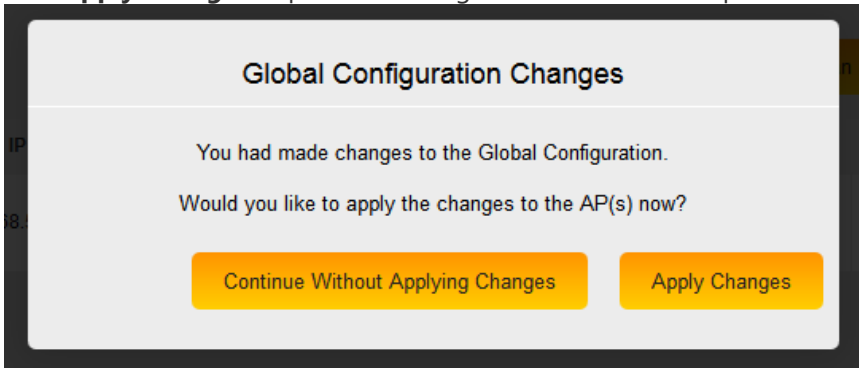

5. When the controller is applying the changes to the access points you will see a screen similar to the following:

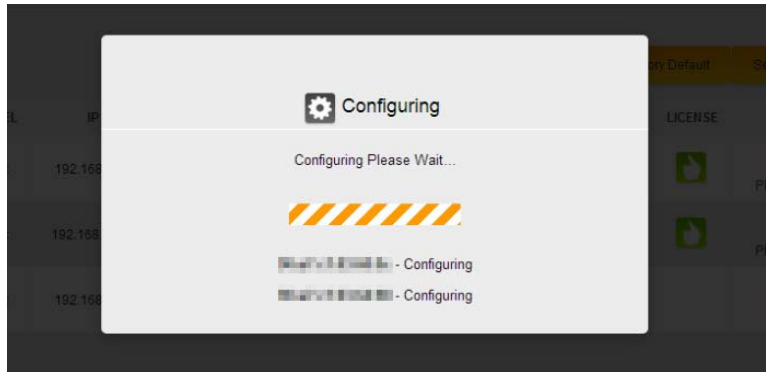

6. Once the NK-1 controller is done applying the configuration to the access points you will be redirected to the access point overview page.

								Remove	Manage / Unmanage	Re-Scan	Factory Default	Configure
AP LOCATION	MODEL	IP	CHANNEL	MAC ADDRESS	POWER	LICENSE	STATUS					
Click to edit	W6x	192.168.50.172	2.4GHz 11	90:a7:c1:03:60:aa	2.4GHz 11 dBm		Online					

## Access Point Overview

After saving and applying the global configuration, you will be directed to the Access Point Overview page.

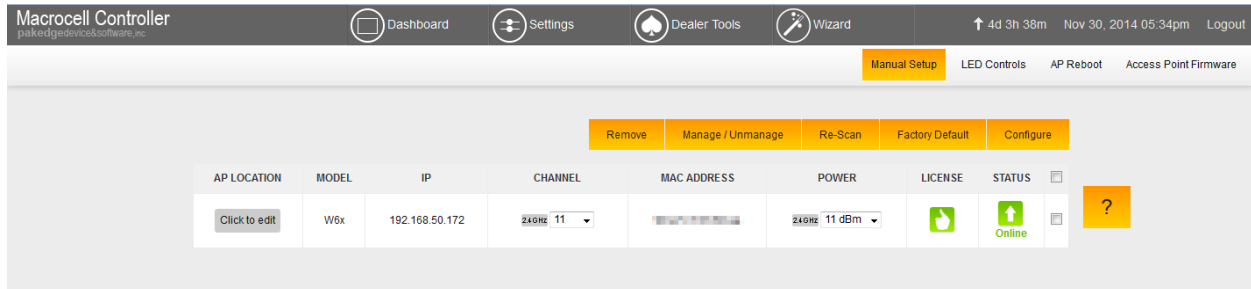

## Dashboard

The dashboard will display the access points that are managed at the top.

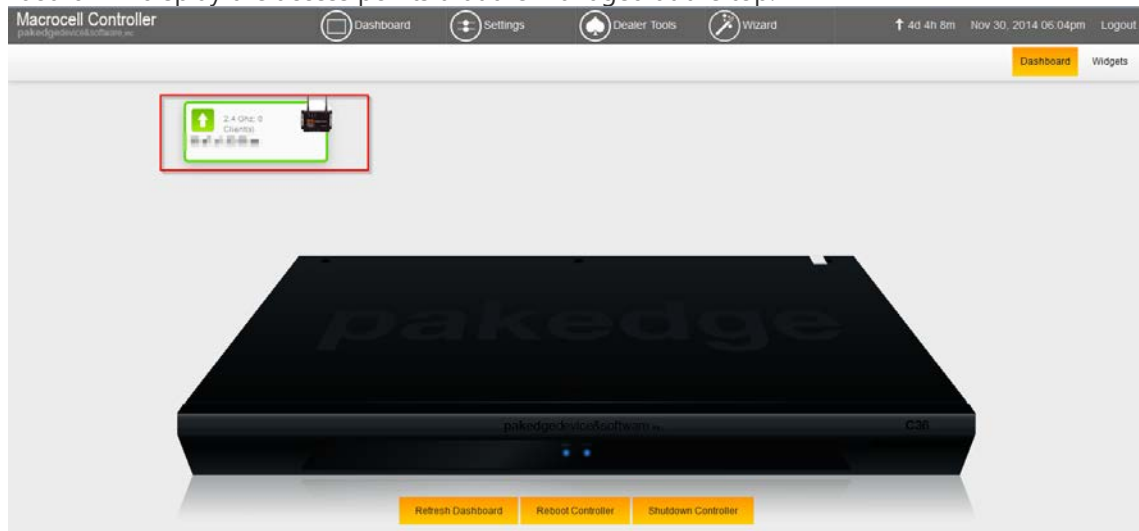

You can click on the widgets button towards the upper right hand side to display all of the widgets on the NK-1.

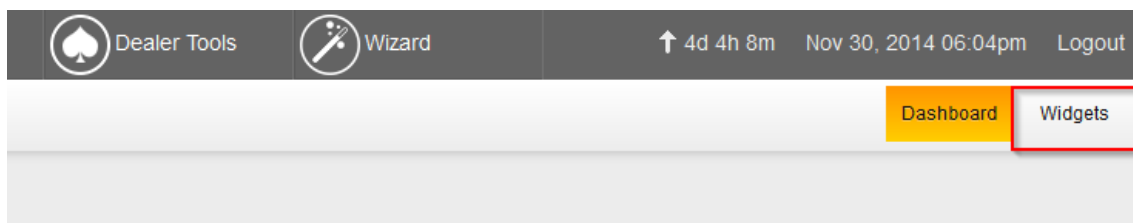

The following is an example of the widgets screen.



The widgets will display important information about the controller.

- **CPU Consumption:** Measures how much of the NK-1 controller's CPU is being used. For best performance, keep it below 65-70%.
- **Memory Consumption:** Measures the NK-1 controller memory usage. For best performance keep it below 60%.

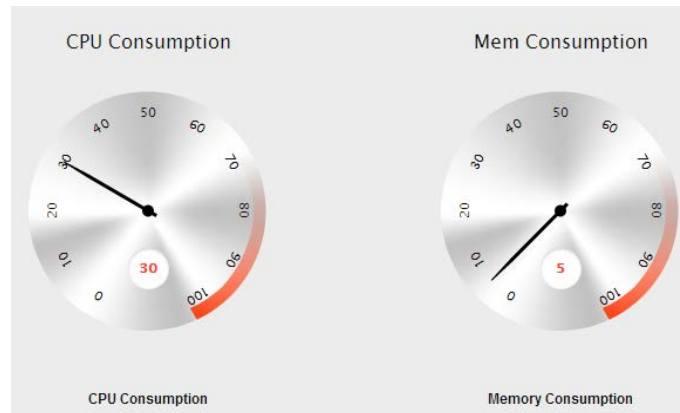

- **AP Health Status:** Display Online, Unhealthy, and Offline APs.
  - **Online AP(s):** Means the AP(s) are configured and online.
  - **Unhealthy AP(s):** Means that the AP(s) either:
    - Do not have the correct configuration.
    - AP(s) are un-managed by the controller and therefore cannot be configured
  - **Offline AP(s):** The NK-1 controller cannot find the AP(s). AP(s) with default IP addresses at 192.168.1.250 will also be listed under this section
  - You can also click on the graph to get more details about which AP(s) are online/offline/unhealthy.

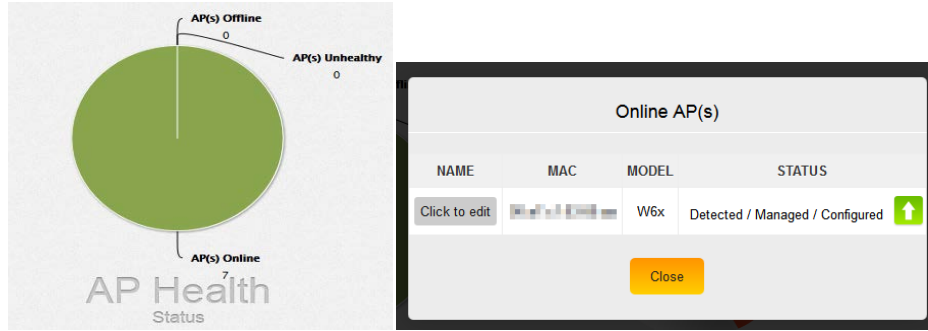

- Clients per AP:** This widget will show you all the clients connected to your APs. You will see a bar graph that lists the number of devices per AP. You can click on this bar to get more information about the connected device, its MAC address and the signal strength.

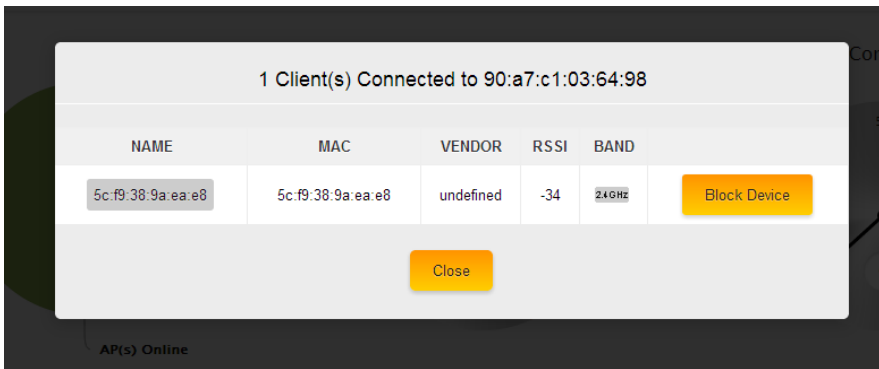
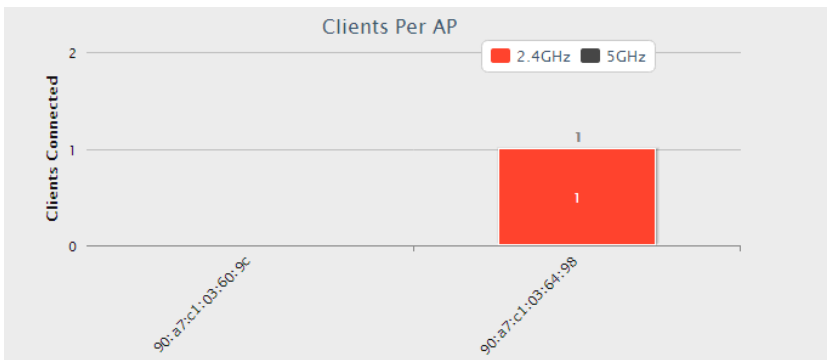

- Mac filter and Wifi Schedule:** This section will display any current wifi schedules or mac filter policies.

MAC Filter(s) : Allow List		
CLIENT NAME	MAC ADDRESS	AP'S EFFECTED
WIFI Schedule(s)		
SCHEDULE NAME	SCHEDULE OPTIONS	SCHEDULE TIME AND DATE
		INCLUDED AP(S)

# Reports

The Reports section gives you summarized and detailed information about your access points and the connected clients. In addition, this section provides logs, when APs go offline/online and whenever the global configuration is updated.

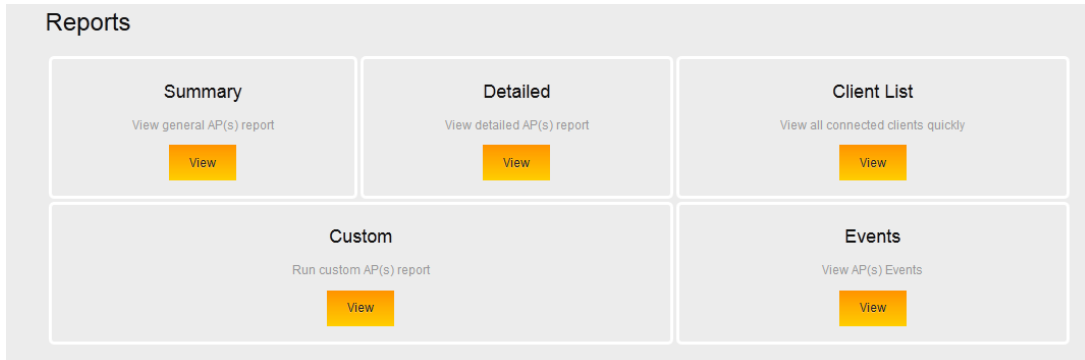

The Reports has 5 sections:

- **Summary:** Provides basic information about your access points, like MAC address, AP model, AP mode (B/G/N), wireless channel, AP firmware version, IP address of the AP and the default gateway. Under Device, if you prefer to not see the MAC address of the AP, you can change the location name of the AP under Settings – Access Point.

Last Updated: 05/08/2013 12:00:00pm [Refresh](#)

Device	Model	Mode	Channel	Firmware	IP	Gateway
90:a7:c1:01:01:0e	W5x	B/G	Auto	2.11	192.168.1.130	
90:a7:c1:01:32:5e	W5x	B/G	Auto	2.11	192.168.1.111	
90:a7:c1:01:3d:16	W5x	B/G	Auto	2.11	192.168.1.110	
90:a7:c1:03:11:b2	W5x	B/G/N	Auto	1.3	192.168.1.138	
90:a7:c1:03:11:ba	W5x	B/G/N	Auto	1.3	192.168.1.115	
90:a7:c1:03:1a:be	W5x	B/G/N	Auto	1.3	192.168.1.113	

- **Detailed:** Provides additional information about your access points and the clients connected to them. You will also see a list of SSIDs, the VLAN ID per SSID, the security settings of each SSID and the number of clients connected to each AP. You can click on the number of clients connected to see a list of the devices with their MAC addresses and the signal strength.

Last Updated: 05/08/2013 12:00:00pm Refresh

Device	Model	Mode	Channel	IP	Gateway	SSID	Security	VLAN	# Clients
90a7c101010e	Wlx	BIG	Auto	192.168.1.130		Vert5Test-1	WPA2-PSK	1	0
						Vert5Test-2	WPA2-PSK	2	
						Vert5Test-3	WPA2-PSK	3	
						Vert5Test-4	WPA2-PSK	4	
90a7c101325e	Wlx	BIG	Auto	192.168.1.111		Vert5Test-1	WPA2-PSK	1	2
						Vert5Test-2	WPA2-PSK	2	
						Vert5Test-3	WPA2-PSK	3	
						Vert5Test-4	WPA2-PSK	4	
90a7c1013d16	Wlx	BIG	Auto	192.168.1.110		Vert5Test-1	WPA2-PSK	1	0
						Vert5Test-2	WPA2-PSK	2	
						Vert5Test-3	WPA2-PSK	3	
						Vert5Test-4	WPA2-PSK	4	
90a7c1031132	Wlx	BIGN	Auto	192.168.1.138		Vert5Test-1	WPA2-PSK-AES	1	0
						Vert5Test-2	WPA2-PSK-AES	2	
						Vert5Test-3	WPA2-PSK-AES	3	
						Vert5Test-4	WPA2-PSK-AES	4	
						Vert5Guest	WPA2-PSK-AES	-	
90a7c10311ba	Wlx	BIGN	Auto	192.168.1.115		Vert5Test-1	WPA2-PSK-AES	1	0
						Vert5Test-2	WPA2-PSK-AES	2	
						Vert5Test-3	WPA2-PSK-AES	3	
						Vert5Test-4	WPA2-PSK-AES	4	
						Vert5Guest	WPA2-PSK-AES	-	
90a7c1031abe	Wlx	BIGN	Auto	192.168.1.113		Vert5Test-1	WPA2-PSK-AES	1	0
						Vert5Test-2	WPA2-PSK-AES	2	
						Vert5Test-3	WPA2-PSK-AES	3	
						Vert5Test-4	WPA2-PSK-AES	4	
						Vert5Guest	WPA2-PSK-AES	-	

- **Custom:** Allows you to create your own reports with the information in the order you prefer to view it. To do so, click **"Create"**.
  1. Select the APs you want to monitor from the **"Available AP"** section. The order from top to bottom the AP(s) are displayed in the **"Monitored AP"** section is the order they will display in the custom report.
  2. Select the data you want to view from the **"Available Data"** section. The order from top to bottom the fields are listed, will display from left to right in the custom report.
  3. Name the report in the **"Save As"** field and click **"Apply"**.
  4. The new custom report will now be available just to the right of **"Detailed"**.

- **Edit/Delete a Custom Report:** If you need to edit or delete a custom report, under **"Reports"** select **"Custom"** and the custom report you need to edit/delete from the drop down box and click **"Edit"**. After hitting **"Edit"** the custom report setup screen with the custom information already in the **"Monitored AP"** and **"Monitored Data"** fields. Here you can make any adjustments that are needed to the custom report and select **"Update"** or if you want to completely remove the report, click **"Remove"**.
- **Events:** The Events tab displays when global configurations are updated as well as when an

AP goes offline or come back online. The date, time and AP affected are recorded as well.

Pages: 1 2 3 4 5 6 7 8 9 10 11 12 13 14

Event	Date	Time	AP Affected
Global Configuration Updated	May 8, 2013	08:43 AM	All APs
Global Configuration Updated	May 8, 2013	08:43 AM	All APs
Global Configuration Updated	May 8, 2013	08:43 AM	All APs
Global Configuration Updated	May 8, 2013	08:43 AM	All APs
AP is offline	May 8, 2013	08:44 AM	90:a7:c1:01:06:b0
AP is online	May 8, 2013	08:44 AM	90:a7:c1:01:06:b0
AP is offline	May 8, 2013	08:44 AM	90:a7:c1:01:3d:16
AP is online	May 8, 2013	08:45 AM	90:a7:c1:01:3d:16
AP is offline	May 8, 2013	08:46 AM	90:a7:c1:01:01:0e

- **Client list:** The Client list displays all of the devices connected wirelessly.

Search:  (MAC Addresses, Client names, Vendors, AP MAC Address, AP Band)

CLIENT MAC ADDRESS	CLIENT NAME	CLIENT VENDOR	AP MAC ADDRESS	AP BAND
90:a7:c1:03:60:aa			90:a7:c1:03:60:aa	2.4Ghz

Showing 1 to 1 of 1 entries

First Previous 1 Next Last

## Settings

### Macrocell Controller

The **Macrocell Controller** option has 7 sections. Here you will be able to perform changes such as changing the password to the controller, resetting the controller, updating firmware and much more.

#### Macrocell Controller

**Administration**  
Edit controller password

[Config](#)

**Maintenance**  
Run maintenance on the controller

[Config](#)

**Controller Firmware**  
Current firmware version

[Config](#)

**Time and Date**  
Edit controller Time, Date, Zone And Format

[Config](#)

**LAN Settings**  
Edit Controller IP, Netmask and Gateway

[Config](#)

**SNMP**  
Enable SNMP

[Config](#)

**License**  
Controller license maintenance

[Config](#)

#### Administration

Here you can change the default password. Click **Change Password**.

USERNAME	CREATED
pakedge	2014-01-16 09:32:09

[Change Password](#)

Type your old password in addition to your new password twice and click **Save**.

**Change Password**

Old Password:

New Password:

New Password Again:

[Save](#)
[Cancel](#)

## Maintenance

Here you can perform several functions. Each function is covered in the next section.

- **Backup Configuration:** The NK-1 controller allows you to save all the changes you made to the controller in case there is any issue and you need to factory default the NK-1 controller. These changes include the Global Configurations, IP Address and host name.
- **Restore Configuration:** Allows you to restore your saved configuration page.
- **Factory Default Controller:** The controller and the AP(s) will reset to default settings.
- **Reboot Controller:** If needed, you can reboot the controller.

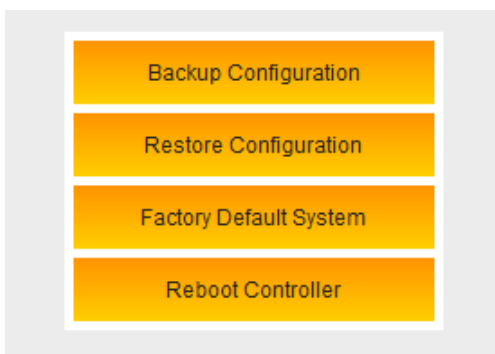

## Controller Firmware

If you have a new firmware, you can upload the file and then apply it to your controller.

**Current Controller Firmware:**

**2.10**

---

**Upload Controller Firmware:**

## Time and Date

In this section you can set the time and date either automatically or manually, the country and if you want the time displayed in a 12 or 24 hour format.

Time and Date

Set Time and Date Automatically

Date and Time: 05/08/2013 11:56 AM

Time Zone: (GMT-08:00) Pacific Time (US & Canada)

Country: United States

Time Format: 12 hour

## LAN Settings

Change the IP address, subnet mask and Gateway of the NK-1 controller.

**LAN SETTINGS**

IP:	192.168.1.35
Netmask:	255.255.255.0
Gateway:	192.168.1.99
Hostname:	c36

## SNMP

Enable/Disable SNMP. By enabling this option, you can use SNMP monitoring tools to report if the NK-1 controller is online/offline and send you notifications if the device goes offline. For more information, ask about our BakPak to the Cloud application.

The image shows a web interface for configuring SNMP. At the top, the title is "SNMP". Below it, there are three rows of configuration options:

- Enabled:** A checkbox that is checked.
- Community Name (Read Only):** A text input field containing the word "public".
- Community Name (Read/Write):** A text input field containing the word "private".

At the bottom center of the form is a yellow "Save" button.

## License

This section displays each access point and their license status. If you are getting a red thumbs down, verify that you have enough licenses for all the access points, the firmware is up to date on each AP and they are being managed by the NK-1 controller.

Location	Model	IP	MAC Address	License
	W6x	192.168.1.113	[blurred]	
	W6x	192.168.1.123	[blurred]	
	W6x	192.168.1.122	[blurred]	

## Access Point

The access point section will allow you to manually configure access points, LED lights on the access points, and reboot the access points.

The image shows a web interface titled "Access Point". It contains three main sections, each with a "View" button:

- Manual Setup:** Subtitle "Manage AP's Manually".
- LED Controls:** Subtitle "Turn On/Off AP LED's".
- AP Reboot:** Subtitle "Reboot AP's".

# Manual

Using the Manual Setup page, you can configure your AP(s) if you decide not to use the Wizard. You would also use this section if you add an additional access point, no need to rerun the Wizard. Below is a detailed explanation of all the options under the “**AP Settings**” page.

- **AP Location:** You can edit and rename this field to give a better understanding of the AP’s physical location (for example, Upstairs Bedroom).



- **Remove:** If you removed an AP from your setup and you do not want the AP to stay listed in the AP table, select the AP and click “**Remove**”.
- **Manage/Unmanage:** This option allows you to toggle an AP to/from being managed. If you want to make an AP a stand-alone device again that is no longer managed by the NK-1 controller, this is the option to do so.
- **Re-Scan:** Scans for AP changes. For example, new added APs and new Status changes.
- **Factory Default:** If you are having any problems configuring the APs, you can always factory default them.
- **Set IP:** By default, all the IPs will have the same IP address of 192.168.1.250. Part of the configuration process is to change the IP addresses of all the APs. You can choose to change the IP using DHCP or setting a static IP address.
- **Configure:** This will apply the global configuration to the selected AP(s).
- You can change the channel and transmit power under the “Channel” and “Power” options. Make sure you click  after making the changes.
- You can always hover over the “?” as this will give you more information about each status and what it represents.

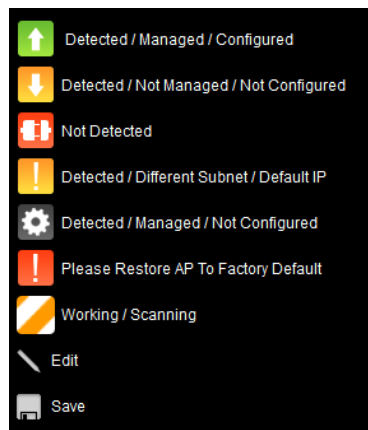

## LED Controls

The LED control section will allow you to turn on/off LEDs on any of the access points. This can be beneficial in trying to locate a particular access point.



To turn off an LED on an access point simply click on the blue square next to the LED you wish to disable on the access point you want to do it on. Then click on save LED settings.



## AP Reboot

The AP reboot section will allow you to either individually reboot an access point or reboot multiple access points at once. To reboot an access point simply click on the check box next to an access point



## Access Point Firmware

This section checks your AP(s) for their firmware version and allows you to update to the latest available firmware version. Under the column, "Status" we have different symbols to indicate what action is needed.

							Re-Scan	Upload Firmware File	Update AP Firmware
AP LOCATION	IP	MODEL	ACTIVE FIRMWARE	AVAILABLE FIRMWARE	STATUS				
1st AP	192.168.50.172	W6x	1.9	1.9	<input checked="" type="checkbox"/>				

- **Upload Firmware File:** Here is where you will upload any newer firmware files that you wish to push to the access points.
- **Update AP Firmware:** After uploading the new firmware file, select the AP(s) that will be receiving the firmware upgrade and click **"Update AP Firmware"**.
- **Re-Scan:** after updating the firmware, you can do a re-scan to detect the new firmware on the AP(s), to verify they are all on the correct version now.

## Adding an Additional Access Point

Below are the steps for adding an additional AP to an existing system:

1. If you are adding a new AP out of the box, the default IP address should be 192.168.1.250. For this AP the **"Status"** will blink, **"Set IP"**. Select the check box next to the **"Set IP"** status and select **"Set IP"**.

									Remove	Manage / Unmanage	Re-Scan	Factory Default	Set IP	Configure
AP LOCATION	MODEL	IP	CHANNEL	MAC ADDRESS	POWER	LICENSE	STATUS							
1st AP	W6x	192.168.1.250						<input checked="" type="checkbox"/>						

2. After setting a static IP or letting the access point obtain one from the DHCP (recommended), the NK-1 controller will check new AP's firmware to see if it matches the firmware of the existing units. If the firmware is out of date, you will need to go to the **"Access Point Firmware"** section to update the firmware on the AP.
3. When the firmware of all the APs match, the status will display **"Please Manage"**. To do so, check the box for the AP and select **"Manage/Unmanage"**.

									Remove	Manage / Unmanage	Re-Scan	Factory Default	Set IP	Configure
AP LOCATION	MODEL	IP	CHANNEL	MAC ADDRESS	POWER	LICENSE	STATUS							
1st AP	W6x	192.168.50.172	24GHz Auto		24GHz 29 dBm			<input checked="" type="checkbox"/>						

4. Now that the AP is set to be managed, you will see that it needs to be configured. Again select the AP and click **"Configure"**. The NK-1 controller will now push the global configuration to the new AP.

AP LOCATION	MODEL	IP	CHANNEL	MAC ADDRESS	POWER	LICENSE	STATUS
1st AP	W6x	192.168.50.172	2.4GHz Auto	[MAC Address]	2.4GHz 29 dBm	[License Icon]	Please Configure

5. Once finished, the access point will show that it is online.

AP LOCATION	MODEL	IP	CHANNEL	MAC ADDRESS	POWER	LICENSE	STATUS
1st AP	W6x	192.168.50.172	2.4GHz Auto	[MAC Address]	2.4GHz 29 dBm	[License Icon]	Online

## Global Configuration

The settings for the Global Configuration section have already been discussed earlier in this manual, in the section, **The Wizard Step 3: Global Configuration**. If you decide to make any changes to your SSIDs or enable/disable the guest network, you can always refer back to the Global Configuration page, make the necessary changes and apply the configuration to the APs.

W6x Global Configuration

<p>Enable: <input checked="" type="checkbox"/> On <input type="checkbox"/> Off</p> <p>SSID: support@2-4</p> <p>Suppressed SSID: <input type="checkbox"/> On <input checked="" type="checkbox"/> Off</p> <p>Station Separation: <input type="checkbox"/> On <input checked="" type="checkbox"/> Off</p> <p>Security: WPA2-PSK</p> <p>Passphrase: [Masked] Show</p> <p>Enable 802.1q tag: <input type="checkbox"/> On <input checked="" type="checkbox"/> Off</p>	<p>Enable: <input checked="" type="checkbox"/> On <input type="checkbox"/> Off</p> <p>SSID: support@2</p> <p>Suppressed SSID: <input type="checkbox"/> On <input checked="" type="checkbox"/> Off</p> <p>Station Separation: <input type="checkbox"/> On <input checked="" type="checkbox"/> Off</p> <p>Security: WPA2-PSK</p> <p>Passphrase: [Masked] Show</p> <p>Enable 802.1q tag: <input type="checkbox"/> On <input checked="" type="checkbox"/> Off VLAN 2</p>
<p>Enable: <input checked="" type="checkbox"/> On <input type="checkbox"/> Off</p> <p>SSID: support@3</p> <p>Suppressed SSID: <input type="checkbox"/> On <input checked="" type="checkbox"/> Off</p> <p>Station Separation: <input type="checkbox"/> On <input checked="" type="checkbox"/> Off</p> <p>Security: WPA2-PSK</p> <p>Passphrase: [Masked] Show</p> <p>Enable 802.1q tag: <input type="checkbox"/> On <input checked="" type="checkbox"/> Off VLAN 3</p>	<p>Enable: <input checked="" type="checkbox"/> On <input type="checkbox"/> Off</p> <p>SSID: C38-4</p> <p>Suppressed SSID: <input type="checkbox"/> On <input checked="" type="checkbox"/> Off</p> <p>Station Separation: <input type="checkbox"/> On <input checked="" type="checkbox"/> Off</p> <p>Security: WPA2-PSK</p> <p>Passphrase: [Masked] Show</p> <p>Enable 802.1q tag: <input type="checkbox"/> On <input checked="" type="checkbox"/> Off</p>

## Advanced

The advanced section will allow you to setup MAC filtering, wireless schedules, and client limit.

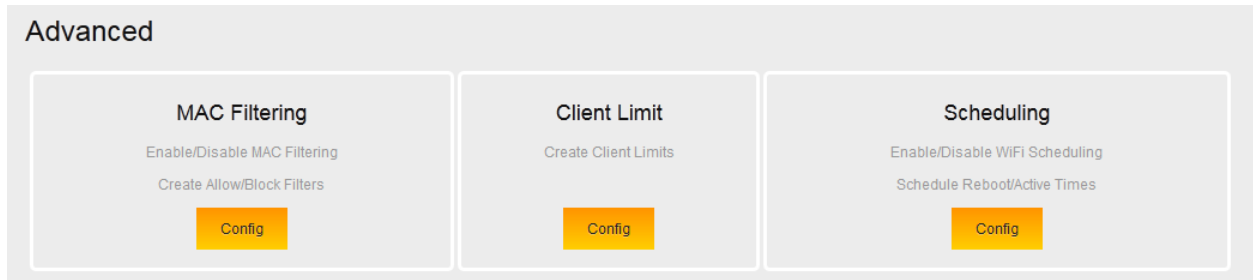

## Mac Filtering

Mac filtering will allow you to allow/deny wireless clients from connecting based on their mac addresses. By default, mac filtering will be disabled. If you want to enable mac filtering, take the following steps.

1. Navigate to the advanced settings page. Click **Config** under MAC filtering.

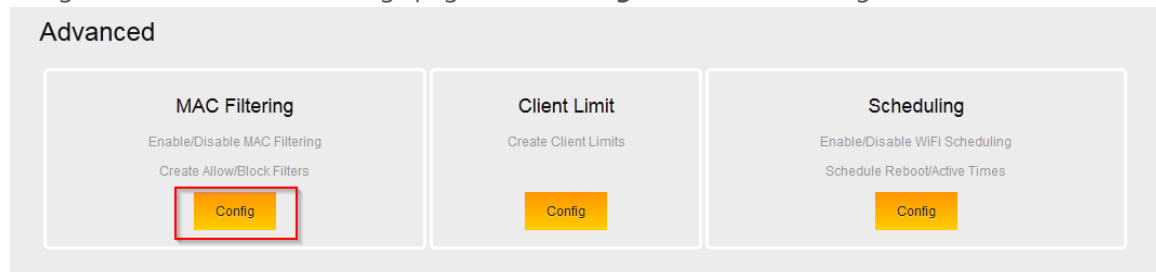

2. By default, MAC filtering is disabled. Click the enable icon.

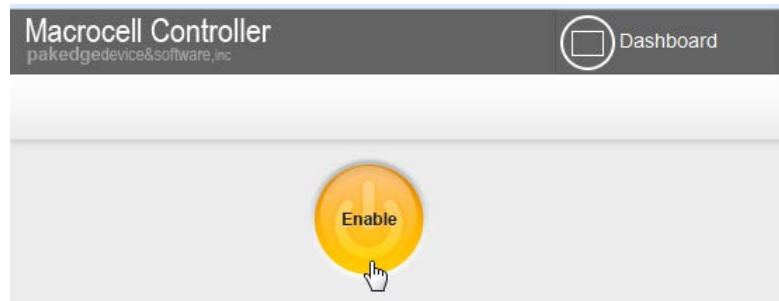

3. Click **Save and continue**.

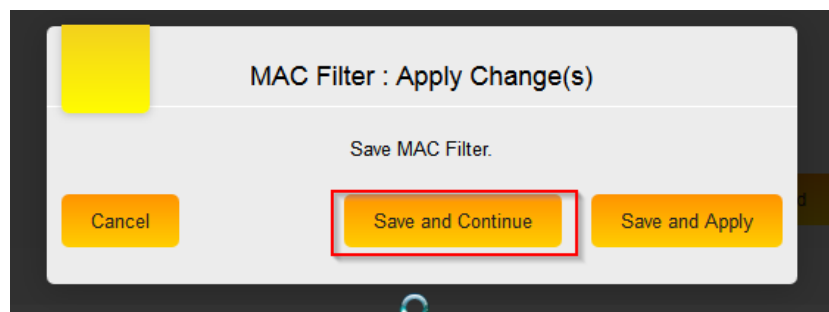

4. Under MAC filtering options you will have two choices.

Allow device in list: This option will configure the access points so that only the mac addresses you specify are allowed to connect to the wireless. All other MAC addresses will not be allowed to connect to the wireless access points.

Block device in list: This option will configure the access points so that only the mac addresses you specify are blocked. All other MAC addresses will be allowed to connect to the wireless access points.

- Once you have selected the MAC filtering option you will need to add a rule that specifies the device(s) you want to allow/deny access. Click **Add**.

Mac Filtering Options  
Allow Device in the List

CLIENT NAME      MAC ADDRESS      AP'S EFFECTED      Select All Devices

No Devices are currently setup for MAC Filtering.

- Enter a **device name** and **device mac address**. Towards the bottom you will be able to select the access points that the mac filtering policy applies to. Once you have entered all the information, click **Save**.

Add MAC Filter

Device Name  
Wireless Device

Device MAC Address  
aa:bb:cc:dd:ee:ff

Select the AP(s) and band you would like to block/allow this device from

Show 10 entries      Search:

LOCATION	MAC	MODEL	BAND	Choose All
		W6x	2.4GHz	<input checked="" type="checkbox"/>

Showing 1 to 1 of 1 entries

Cancel      Save

- Click **Apply**, and then click **Save and Apply** to finalize the settings.

Mac Filtering Options  
Allow Device in the List

CLIENT NAME      MAC ADDRESS      AP'S EFFECTED      Select All Devices

Wireless Device	aa:bb:cc:dd:ee:ff	2.4GHz	<input type="checkbox"/>
-----------------	-------------------	--------	--------------------------

- You can also block a device from your wireless network from the widgets page. Navigate to the dashboard and click on the widgets button on the upper right hand side.



- Click on the bar graph for the access point that has the wireless client that you wish to block.



- Find the mac address of the wireless client you wish to block from the wireless network. You will need to change the name of the device. By default it will simply display the mac address for the name. Once you have filled in a name for the wireless device click on **block device**.

1 Client(s) Connected to [blurred]

NAME	MAC	VENDOR	RSSI	BAND	
iPhone	[blurred]		-84	2.4GHz	Block Device

Close

- You will then see the following message letting you know that the mac filtering feature will be changed to block the device you have selected. Click **Yes** to apply the settings.

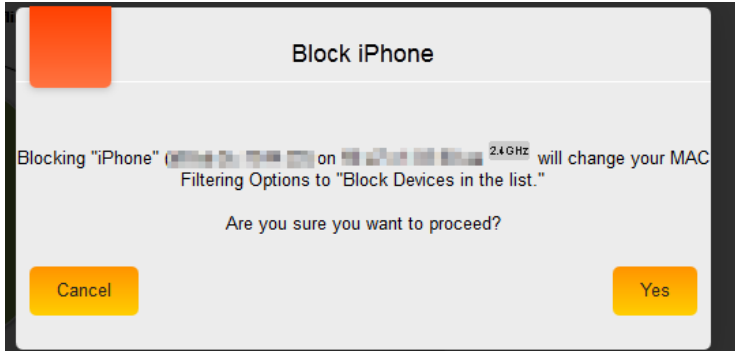

12. You can also unblock a device from the same screen. The following shows an example of this.

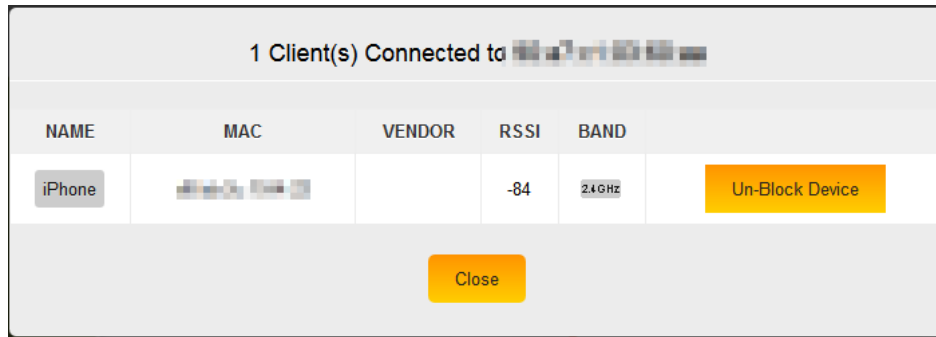

## Client Limit

The Client limit option will prevent any W7 access points from becoming overburdened with too many wireless clients. By default this option is enabled. This means that no more than 127 wireless clients will be allowed to associate with a W7. The W6 access point does not support the client limit feature.

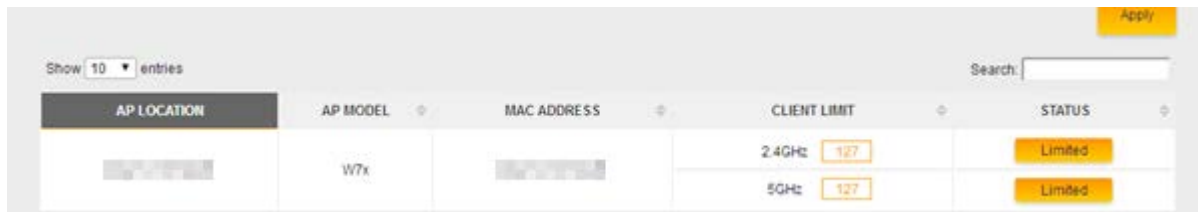

If you wish to disable the client limit for a W7 you can simply click on limited button next to the band that wish to disable the client limit on. You can disable it on both bands if you wish.



# Scheduling

The scheduling feature will allow you to setup a wifi schedule so that the wireless to only be active during the times you want. By default the scheduling is disabled. To configure a schedule please take the following steps.

1. Navigate to the advanced settings and click **Config** under Scheduling.

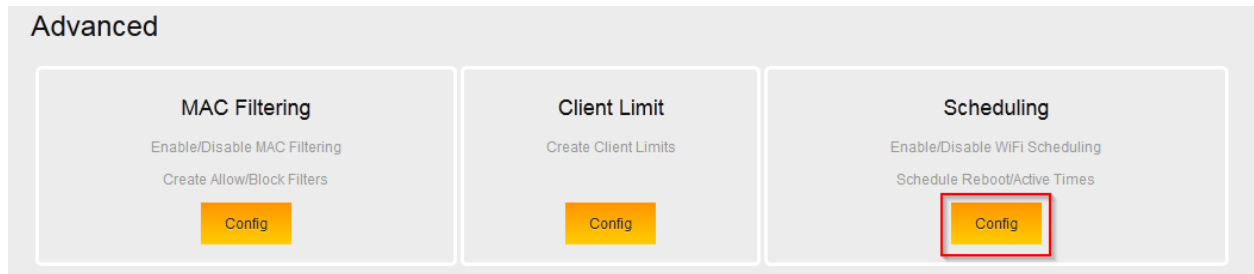

2. Hover your mouse over the button that says disabled and then click on it. This will enable the wifi scheduling.

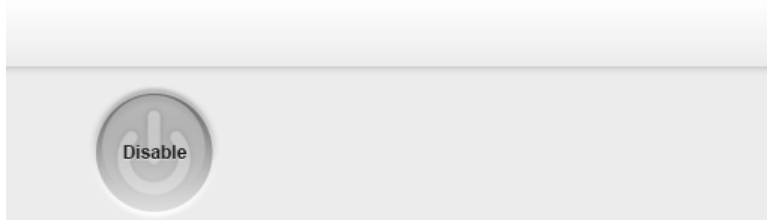

3. You will get a message asking if you want to apply the changes now. Click **Save and Continue**.

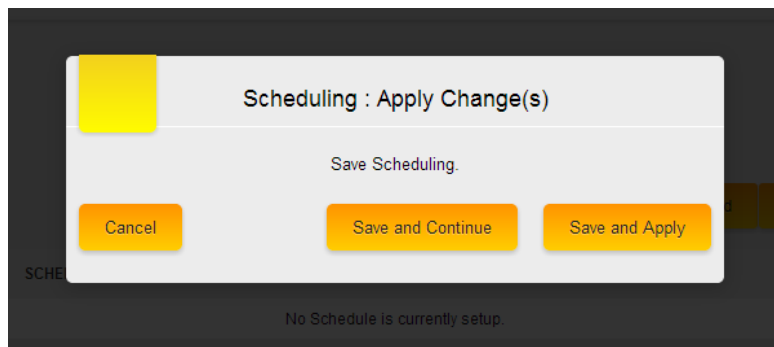

4. Now you will be able to add a schedule. Click **Add**.

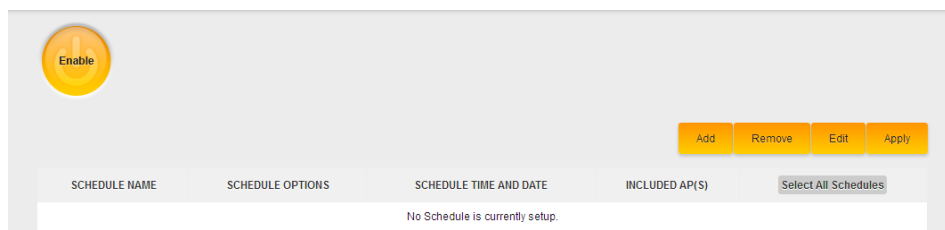

5. Here you will be able to define the parameters of the schedule. Each of these options is described next.

- **Schedule Name:** This is the name of the schedule.
- **Schedule Options:** You will be able to set the access points to either reboot, have both the 2.4 GHz and 5 GHz bands active or only have a particular band active.
- **Day:** This will allow you to specify which days you want the schedule to be active. Selecting everyday means the schedule will be active 7 days a week. You can also select which days you want the schedule to apply to.
- **Time:** If you check the box "All day" the schedule will apply 24 hours a day. You can also specify a start and end time for the days you have selected. If you chose to specify the time please be sure to use a 24 hour clock.
- **Available AP(s):** Here you will be able to select which access points you want the schedule to apply to. If you did not name the access points when going through the wizard then only the mac address of that access point will be displayed. To select an access point simply click on it and then click on the arrow that points to the right hand side. The access point will then be moved over to the Added AP(s) section.

6. Once you have finished entering the information for the schedule click on save. The schedule will now

be listed.

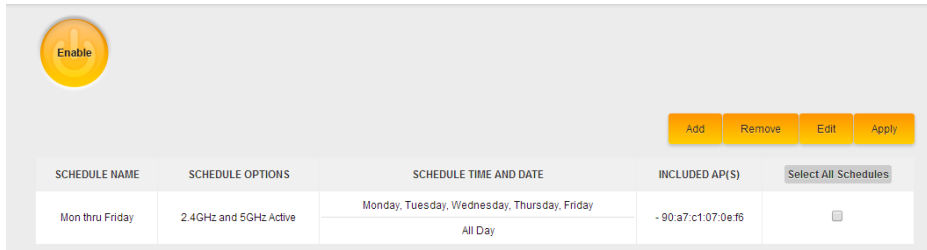

- Click on apply and then click on **save and apply**.

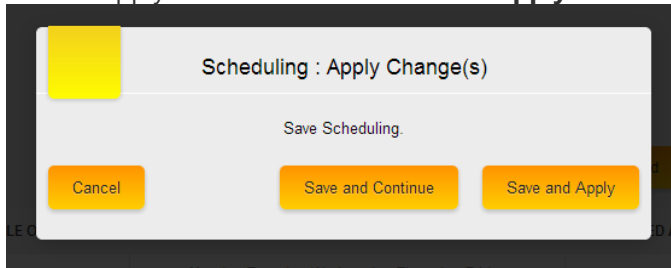

- The controller will then apply the settings.

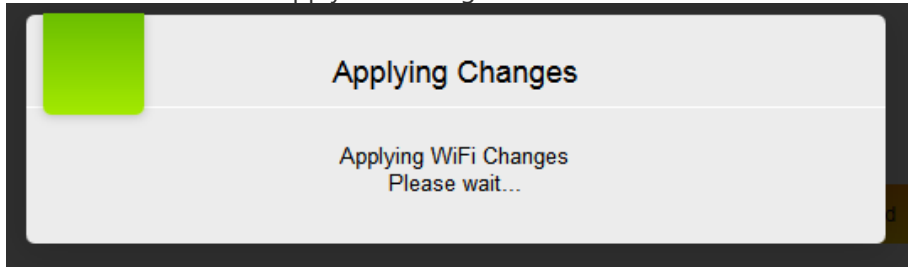

- Once finished you will be returned to the scheduling section.

## Site Survey

The site survey will allow you to do a channel scan from any of the access points that the NK-1 controller has managed. Take the following steps to perform a channel scan on an access point.

- Navigate to Dealer Tools and click **Site Survey**.

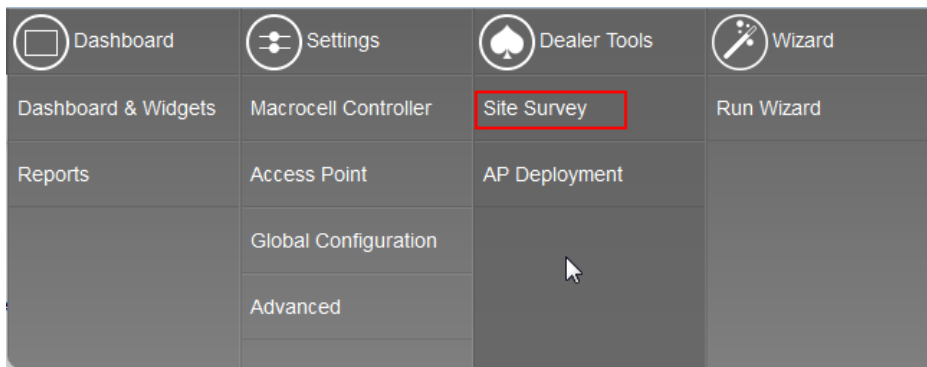

- Here you can select an access point from which you would like to do a site survey from. To do so, simply click on the radio button for the access point, and then click on **site survey**.



- Once the site survey is complete you will see a list of the access points in the area along with their channels and signal strength. The surrounding SSIDs will also be displayed in the graph. **Rogue AP** indicates that it is a non-pakedge access point. For 2.4 GHz, it is best to use channels 1, 6 and 11. These are the only non-overlapping channels available for use in the 2.4 GHz band. The signal strength of the access point is important to note. The closer the number is to zero, the stronger the signal. Any access points that are seen at -75 or greater can be potential sources of interference. In case you may have many neighboring access points, you can set your access points to use a 20 MHz channel width to reduce the chances of being caught in interference.

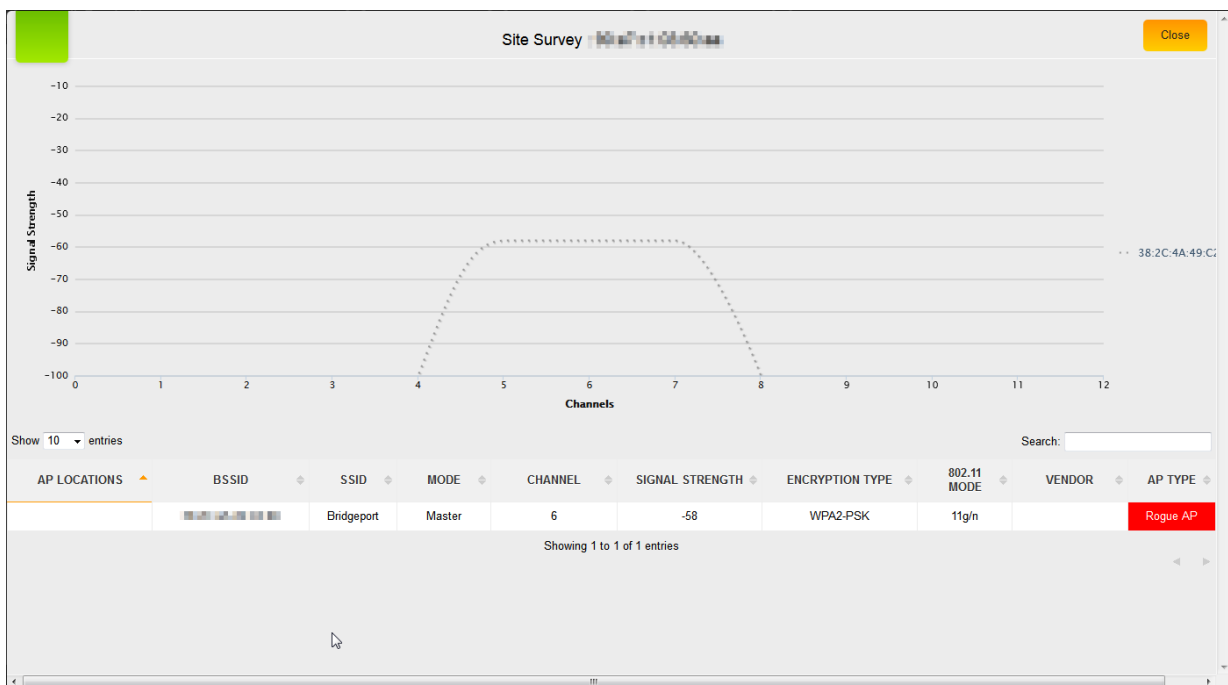

Note: If the 2.4 GHz is heavily populated with nearby access points, you may want to consider using a dual band access point such as the W7. Interference from neighboring access points can cause issues with wireless connectivity.

- If you are using a W7, you will have a site survey for the 5 GHz. Click the **View 5 GHz** option.



5. Here you will see the site survey for 5 GHz. It will look very similar to the 2.4 GHz site survey. Unlike the 2.4 GHz, all of the channels in the 5 GHz band are non-overlapping. This is critical for avoiding interference. As long as each access point is set to a different channel they will not cause interference for one another.

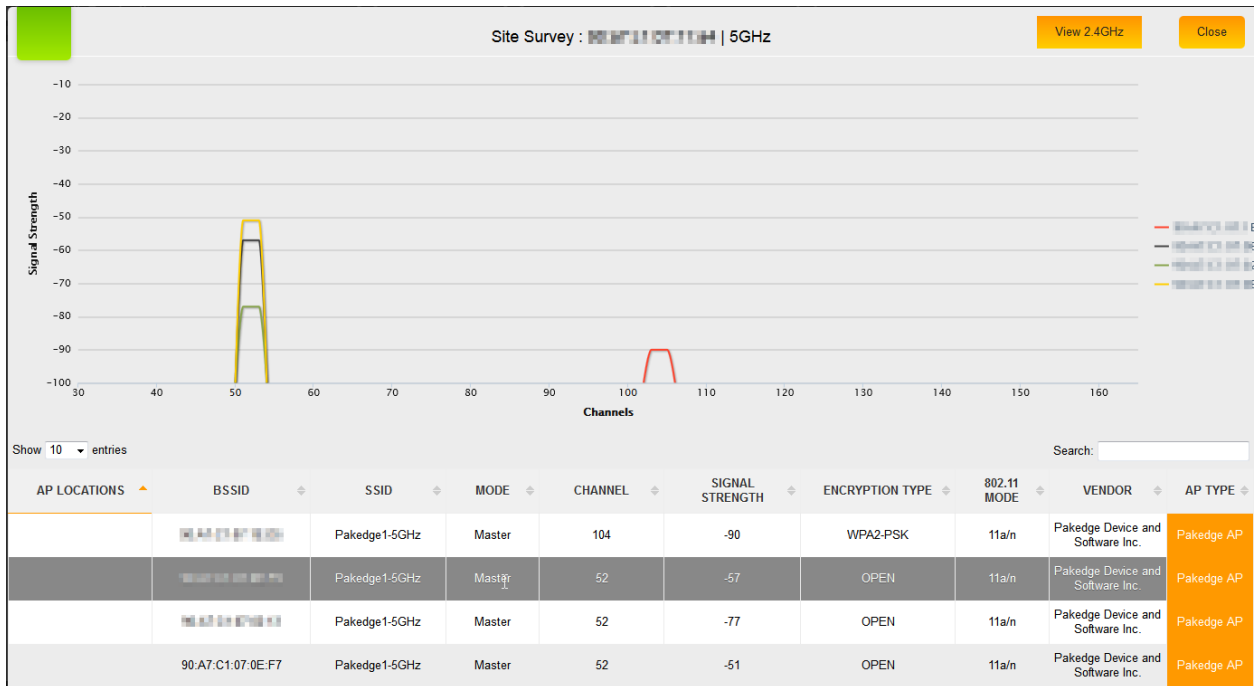

Note: While the 5 GHz is great for avoiding interference, it is important to note that you will generally get less coverage from it compared to the 2.4 GHz. This means you may need more access points with 5 GHz to cover the same area as if you were using 2.4 GHz.

## AP Deployment

The AP Deployment page lets you upload floor plans onto the NK-1 controller and create a heat map for your site to assist with the placement of access points. This will help optimize wireless coverage throughout the property.

To configure AP deployment, follow these steps:

1. Navigate to Dealer Tools and click **AP Deployment**.

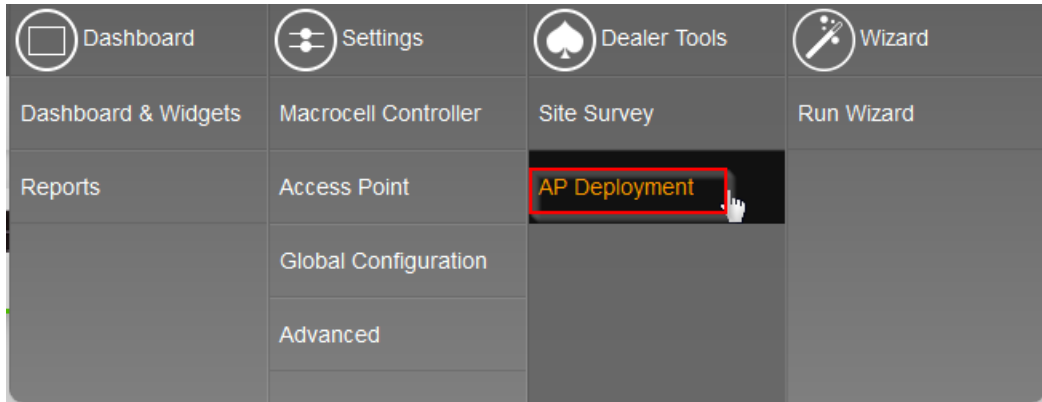

- You will see a page explaining that the controller is scanning for access points. This page will disappear once the scan is over.

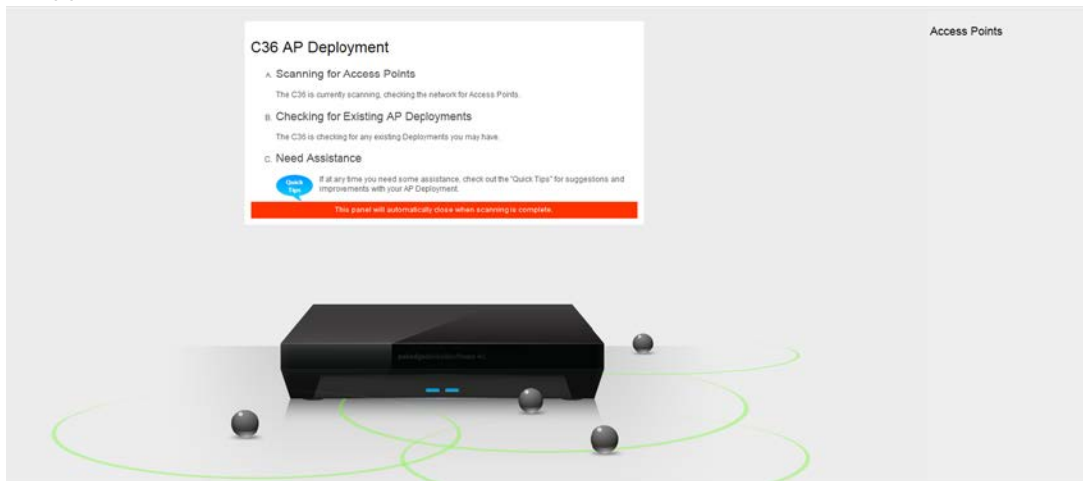

- You will then be presented with the following page. Here you will be able to upload a floor plan onto the NK-1 controller and create the heat map.

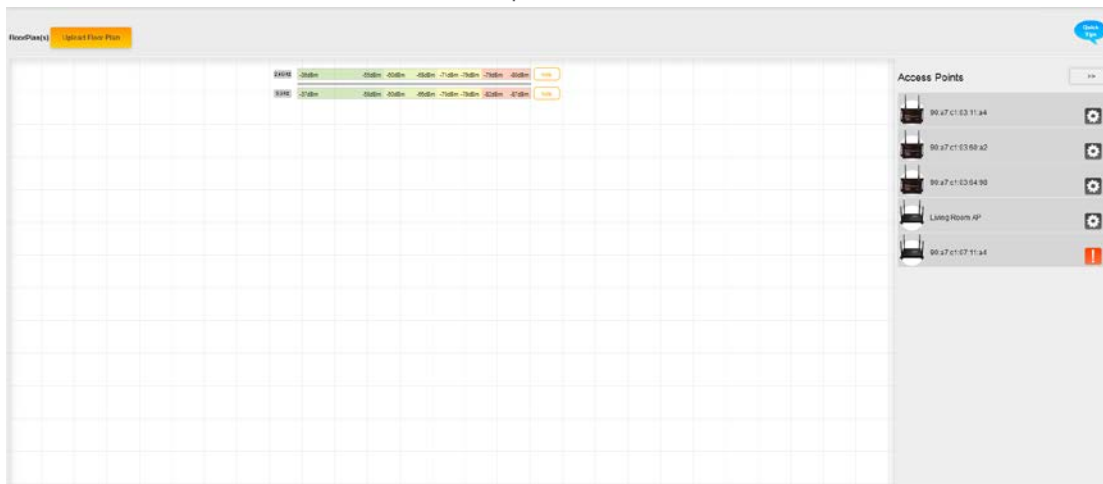

- Click on **Upload Floor Plan**.

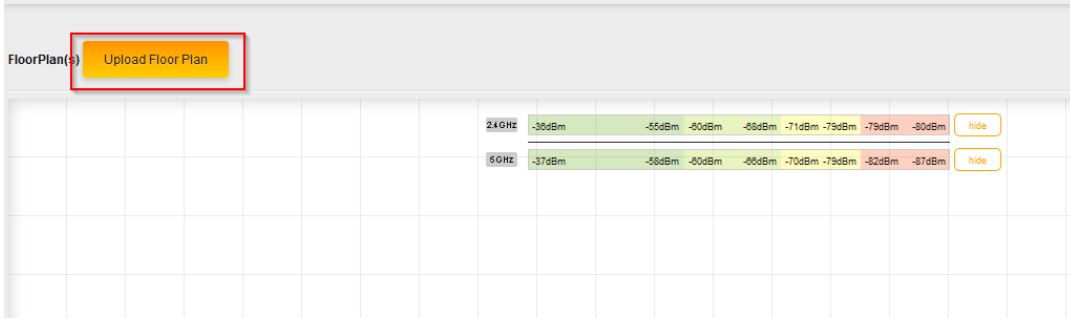

- Upload your floor plan. Note that you can only upload .jpeg or .png file types.

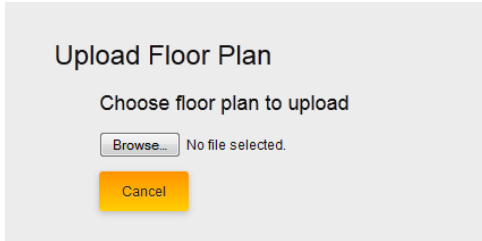

- Enter a name for your floor plan and click **continue**.

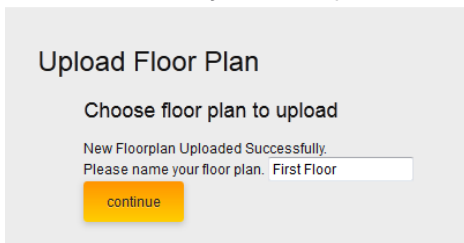

- You will now see your floor plan on the NK-1 controller.

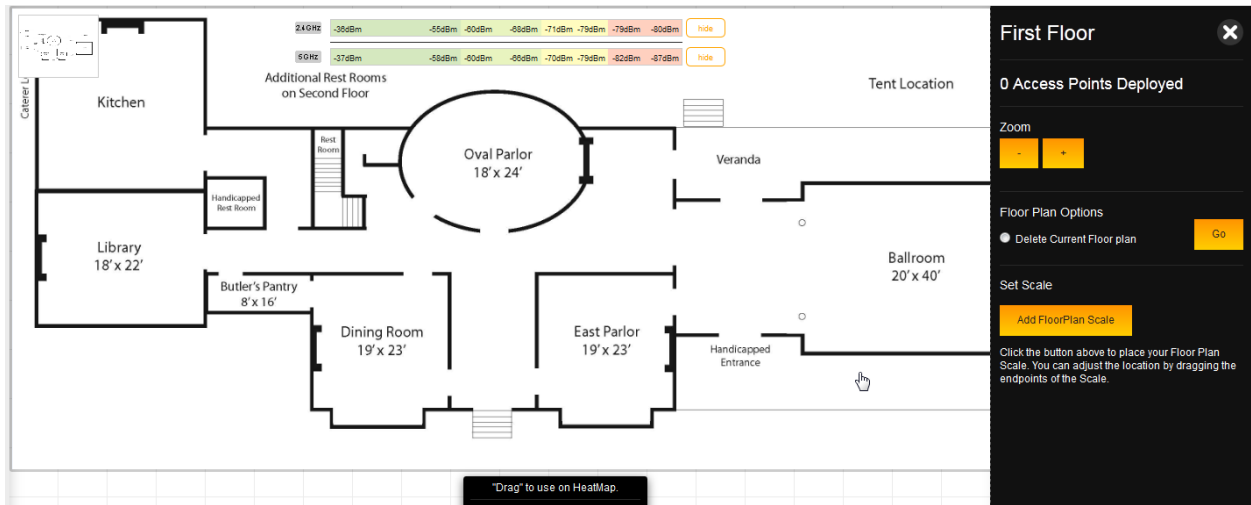

- Before you can add access points to the heat map, you will need to set a scale for the NK-1 controller. This will tell the NK-1 controller how large the site is and display the proper coverage of an access point. To set the scale, click **Add Floor Plan Scale**.

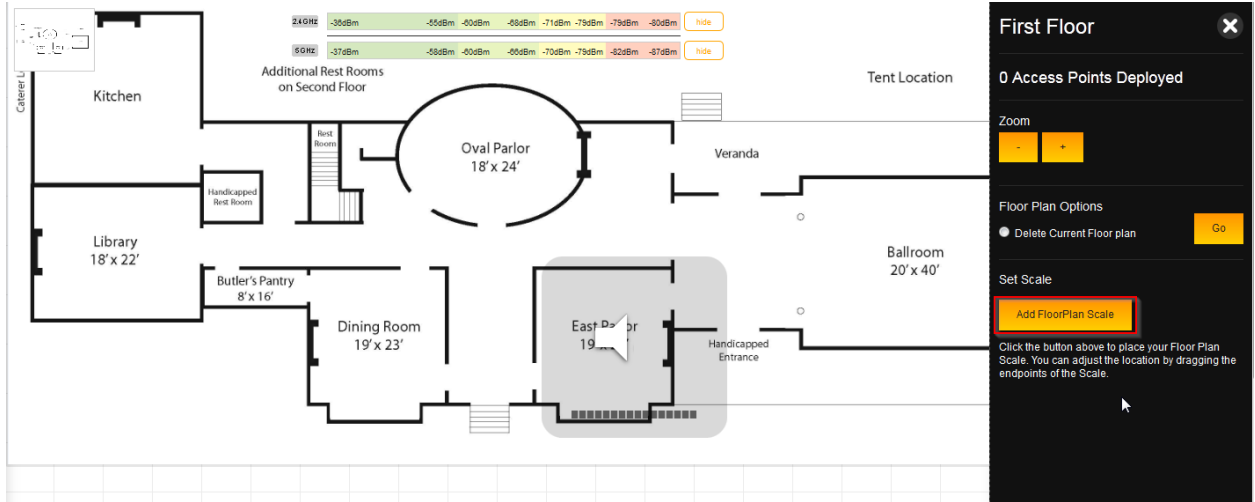

- You will now have a line that you can maneuver as you like. Move the end points to a spot on the floor plan with a known distance.

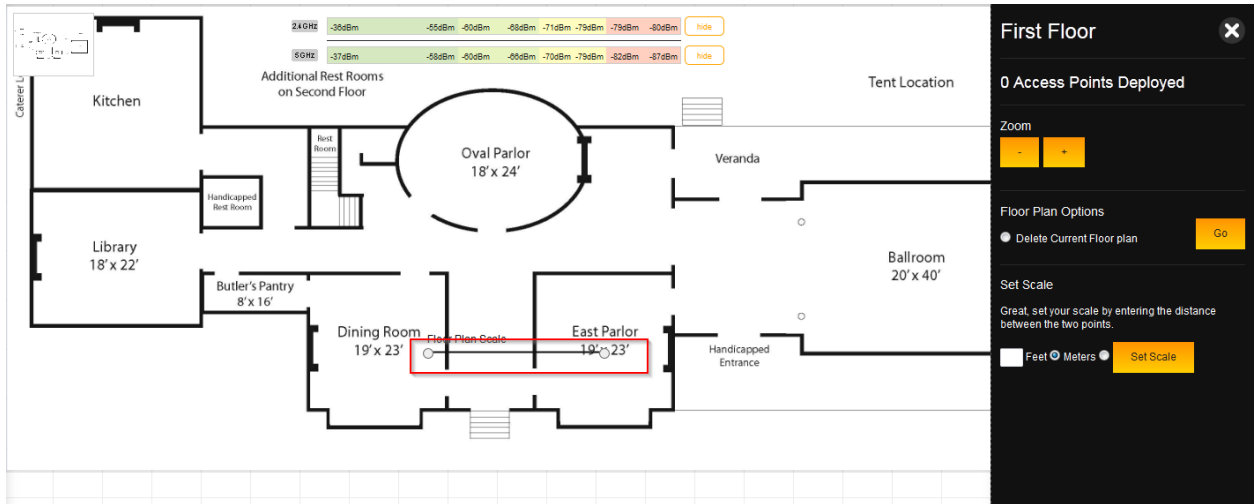

- Enter the distance in either feet or meters. Click **Set Scale**.

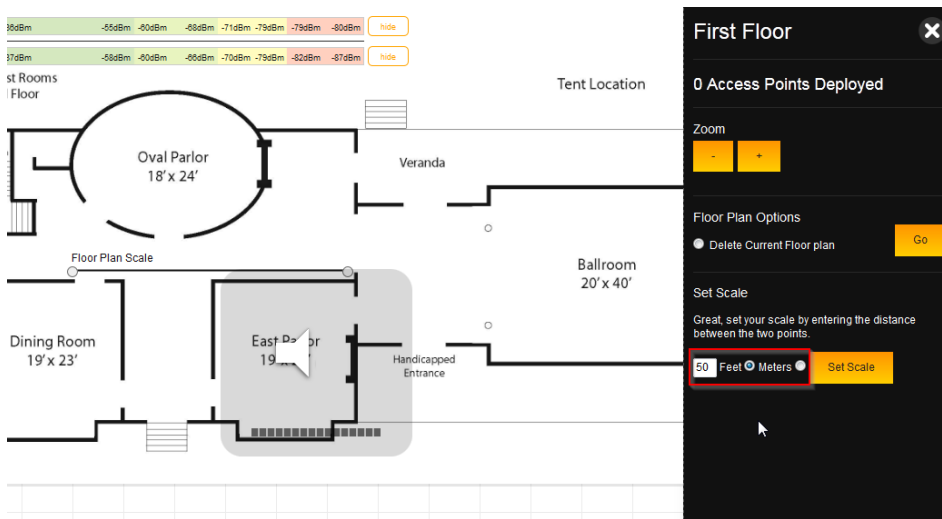

11. The scale is now set.

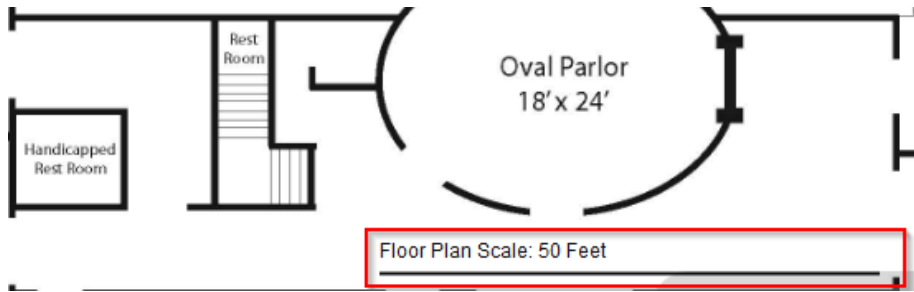

12. With the scale set, you can now close the menu on the right hand side

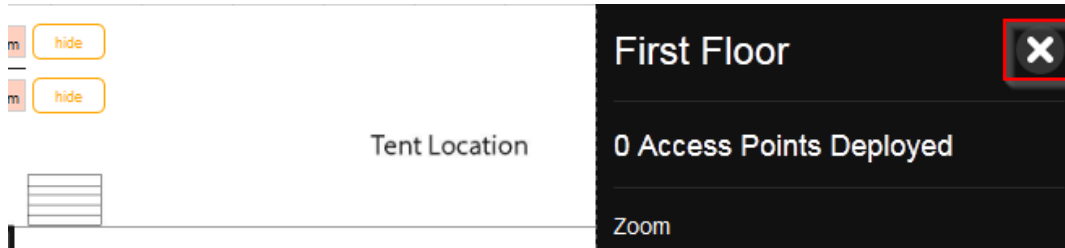

13. Now that the scale is set, we can begin adding access points. Simply drag an access point to the floor plan to view the coverage that it can provide. You can continue adding access points to the map.

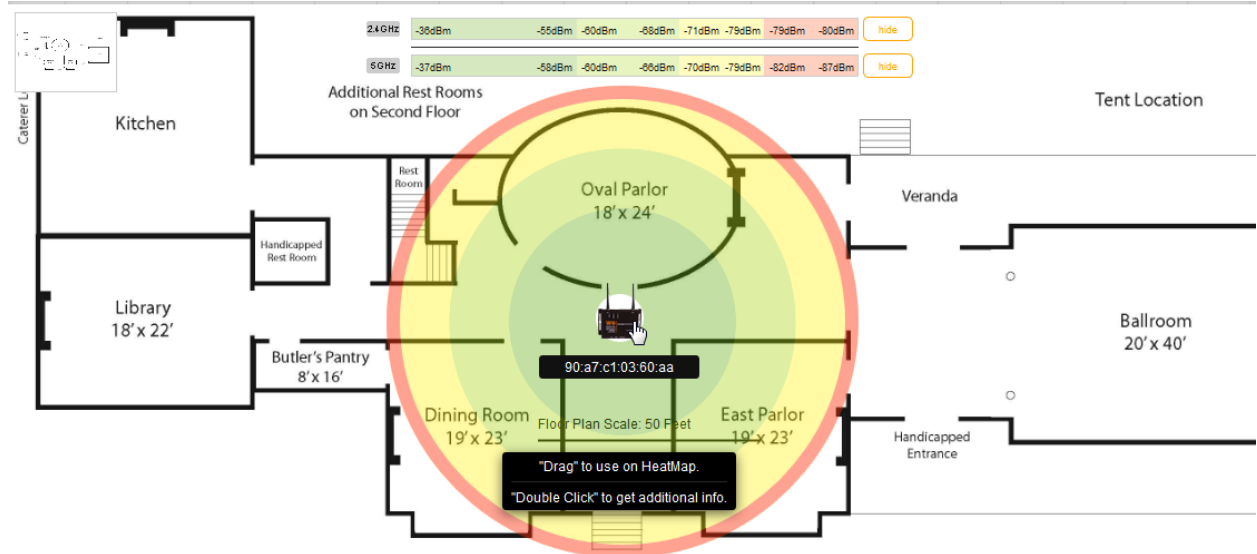

14. Each access point has a multi-colored circle around it. The further an area is from an access point, the weaker the signal. Color changes indicate a change in signal strength.

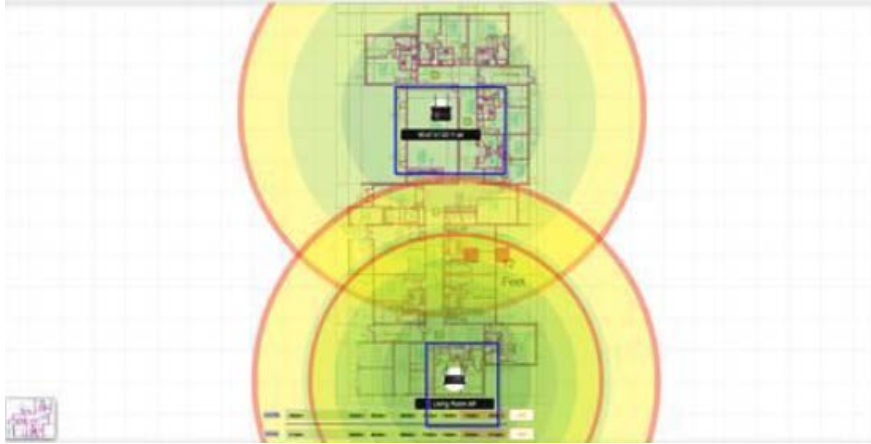

15. To remove an access point, double-click it and then click **Remove AP**.

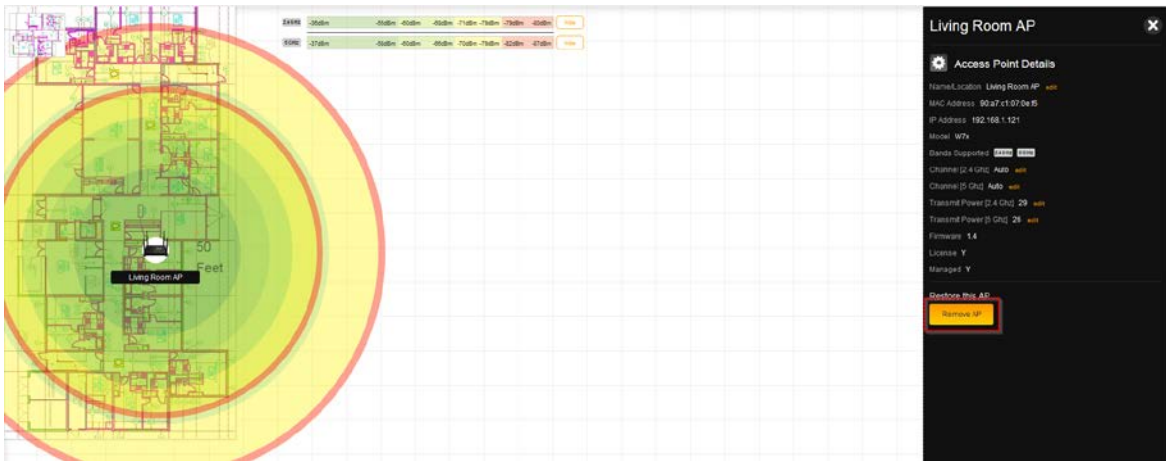

16. When placing a W7 access point on a floor plan, you will see two circles. The smaller circle represents the 5 GHz range and the wider circle represents the 2.4 GHz range. You can hide either band from the heat map by clicking **hide** on the band you wish to remove.



17. You can double-click on any of the access points on the heat map to view its additional details.

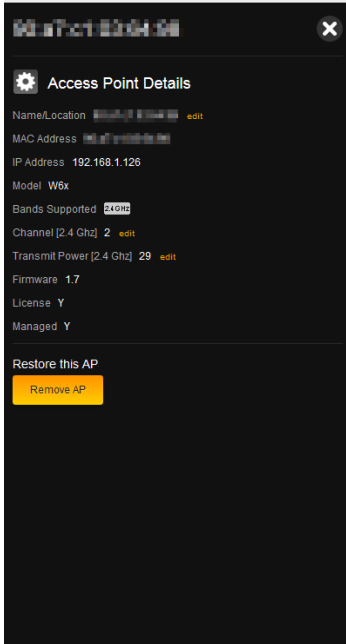

18. From the Additional Point Details menu you can change the **Name/Location**, **Channel**, and **Transmit Power** of your individual access points.
19. To change the Name/Location, click on **edit**.

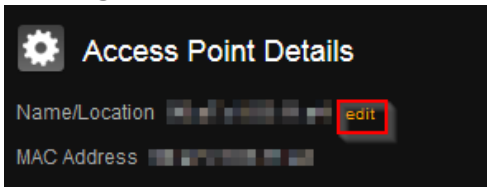

20. The name of an access point is its MAC address by default. To enter a new name, simply click in the text box and begin typing. Click **Save** once finished.

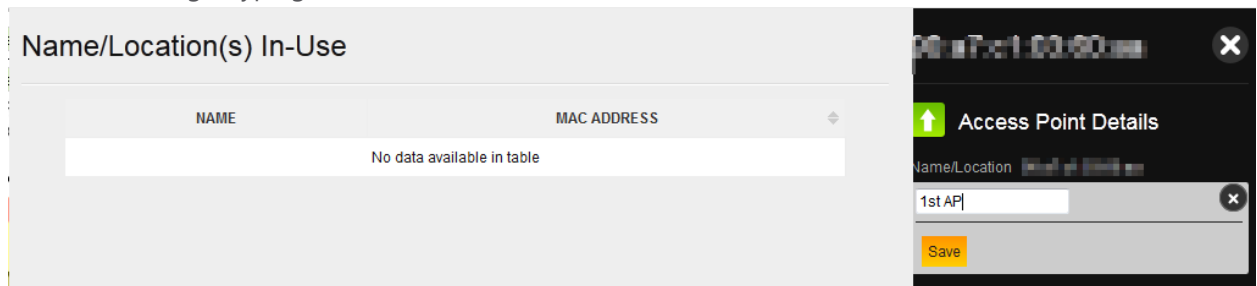

21. To change the channel of the WAP, click **edit**.

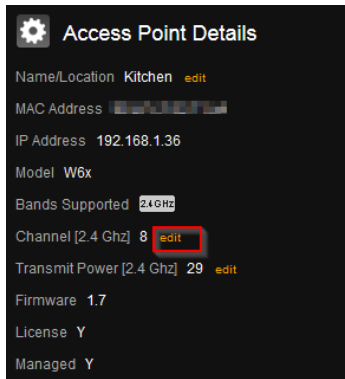

22. Select the channel of the access point. To leave the access point on auto channel, select **auto**.

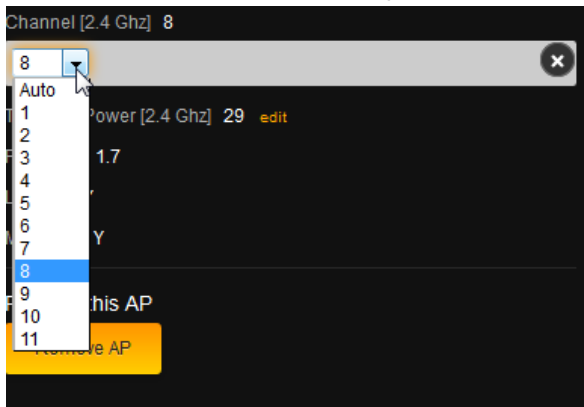

23. If you wish to continue making changes to your heat map, click **Save**. This will save your changes but not apply them—that way, you can finish the configuration of your heat map. If you want to apply the changes to the Global Configuration, click **Save and Apply Changes**.

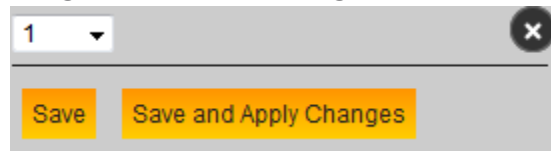

Please note that this will cause your access points to update, and during that time the heat map will not be accessible. It is best to finish the configurations on all of your access points before you perform an update.

24. To change the transmit power, click **edit**.

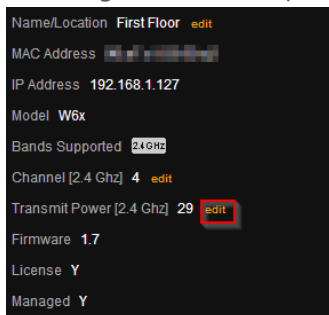

25. Select the power output you would like to use for the access point. It is set at its maximum output by default.

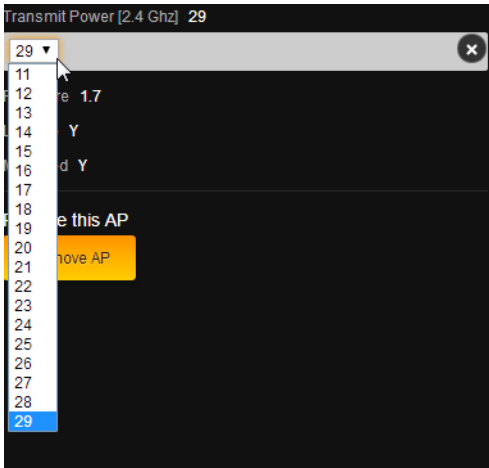

26. Click Save AP Deployment once you are finished with your floor plan.

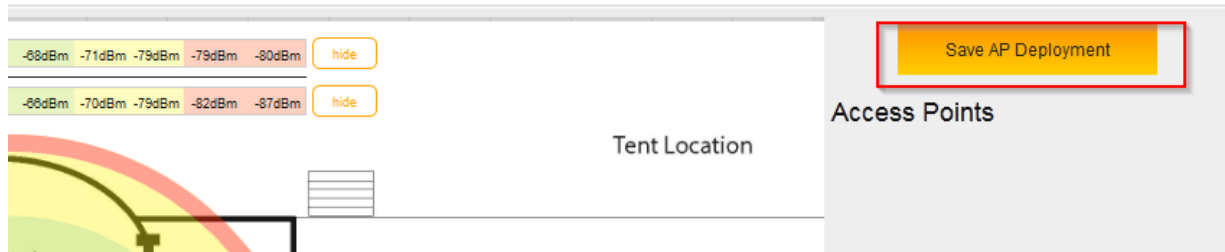

# Configuring the NK-1 Network Cloud Patroller

## Step 1: Login

1. Connect the NK-1 to power and push the power switch on the rear panel. The PWR LED will light up.
2. Connect a computer to the NK-1 through an Ethernet cable. Enter 192.168.1.240 into the address bar of your web browser. You should see a login page. In the username box, type **pakedge**. In the password box, type **pakedge** and click **Login**.



**Note:** If your computer is not set to the default IP scheme of the NK-1 (192.168.1.X), you must first configure the TCP/IP settings on your computer to log in to the NK-1 through a web browser. Please refer to Pages 9-10 on how to configure the TCP/IP settings on your computer.

Following page will display when logged in to the NK-1 Network Cloud Patroller:

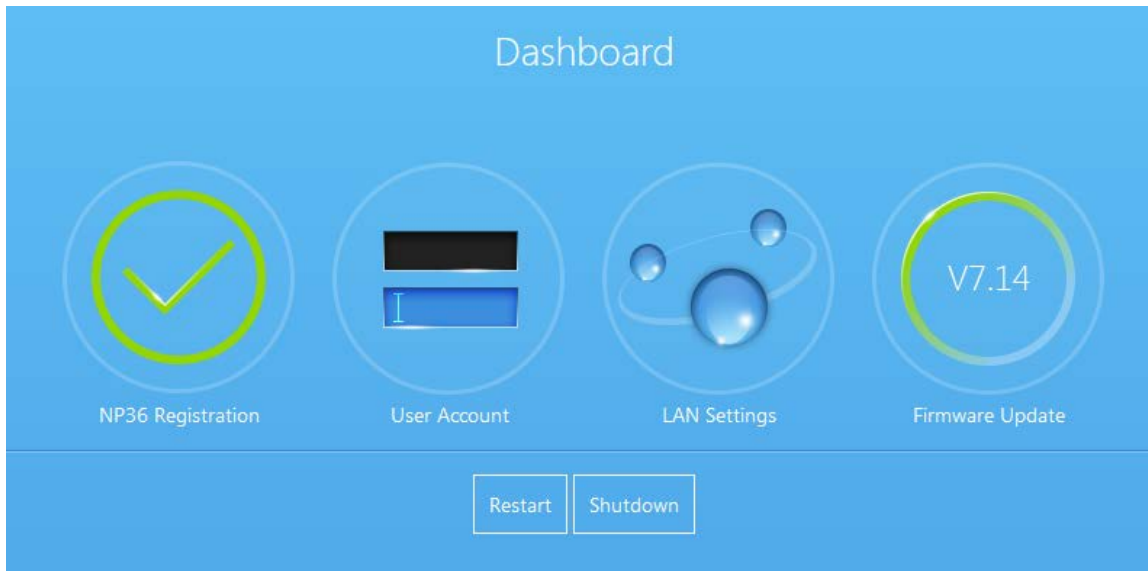

## Step2: Changing the IP Address of the Patroller

1. Log into the Patroller and click **on LAN Settings**.
2. Enter the IP address, subnet mask and default gateway and click **Save**.

The screenshot shows the "LAN Settings" configuration page. It has a blue background with the title "LAN Settings" at the top center. Below the title are four input fields with labels above them: "IP ADDRESS" (192.168.1.237), "SUBNET MASK" (255.255.255.2), "DEFAULT GATEWAY" (192.168.1.99), and "HOSTNAME" (empty). At the bottom of the page are two buttons: "Update" and "Cancel".

Now that your Patroller has the correct IP information and matches your network's scheme, you are ready to connect it to either a switch or directly to the router.

## Creating a Pakedge Cloud Account from the Cloud

1. Open a web browser and enter the following URL:
2. <https://cloud.pakedge.com>
3. Click on **Create a Dealer Admin Account**.
4. Enter an email address, a new password, your time zone and the dealer code.



Register for myBakpak

A **dealer code** is required to create an admin account.

- If you have already created an admin account, please go back to login page and use that account to log in.
- If you are a first time dealer and a first time BakPak user and do not yet have a **Dealer Code**, please contact pakedge sales at [\(650\) 385-8702](tel:650-385-8702) to request a **Dealer Code**. Be ready to verify your:
  - **dealer name**
  - **pakedge account number**
  - **email address**.
- If you already have your **Dealer Code**, proceed with registration.

Email Address [Limit 30 Characters]	<input type="text"/>	Password	<input type="password"/>
Confirm Email Address	<input type="text"/>	Confirm Password	<input type="password"/>
Timezone	<input type="text" value="US/Eastern"/>	Enter Dealer Code	<input type="text"/>

Register

Cancel

5. Click Register.
6. You should now be logged in to the Pakedge Cloud Server.

## Create Pakedge Cloud Account and Register the NK-1 Patroller

You can create a Cloud account and register the NK-1 patroller at the same time. This requires the following steps:

1. Ensure that the NK-1 patroller is connected to your network.
2. Open a web browser and enter the NK-1 Patroller's IP address in the address bar. The default IP address is 192.168.1.240.
3. The following login page should appear:



4. Log in with the default username, **pakedge**, and default password, **pakedgen**.
5. Once you log in, you will be redirected to the following page:

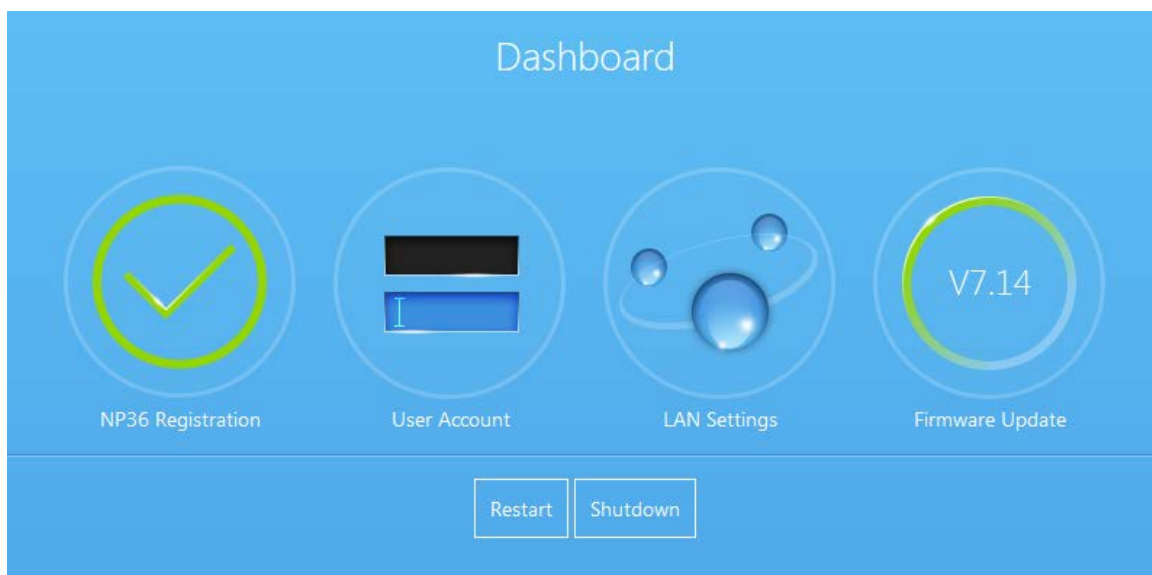

6. Click on **Registration**.
7. You will be redirected to a registration page.



## Register for myBakpak

A **dealer code** is required to create an admin account.

- If you have already created an admin account, please go back to login page and use that account to log in.
- If you are a first time dealer and a first time BakPak user and do not yet have a **Dealer Code**, please contact pakedge sales at [\(650\) 385-8702](tel:6503858702) to request a **Dealer Code**. Be ready to verify your:
  - **dealer name**
  - **pakedge account number**
  - **email address.**
- If you already have your **Dealer Code**, proceed with registration.

Email Address	<input type="text"/>	Password	<input type="password"/>
[Limit 30 Characters]		Confirm Password	<input type="password"/>
Confirm Email Address	<input type="text"/>		
Timezone	<input type="text" value="US/Eastern"/>	Enter Dealer Code	<input type="text"/>



8. Enter an email address, a password, a name for your Patroller, and a timezone. Once you have entered that information, click on **Register**.
9. You should be redirected to **mybakpak.com** on your new account.

## Registering the Patroller with an Existing User

Please take the following steps to register the Patroller with an existing cloud account.

1. Create a Pakedge Cloud Account using the steps provided earlier.
2. Open a web browser and enter your Patroller's IP address in the address bar. The default IP address is 192.168.1.240.
3. You will see the login page for the Patroller.



4. Log in with the default username, **pakedge**, and default password, **pakedgep**.
5. Once you log in, you will be redirected to the following page.

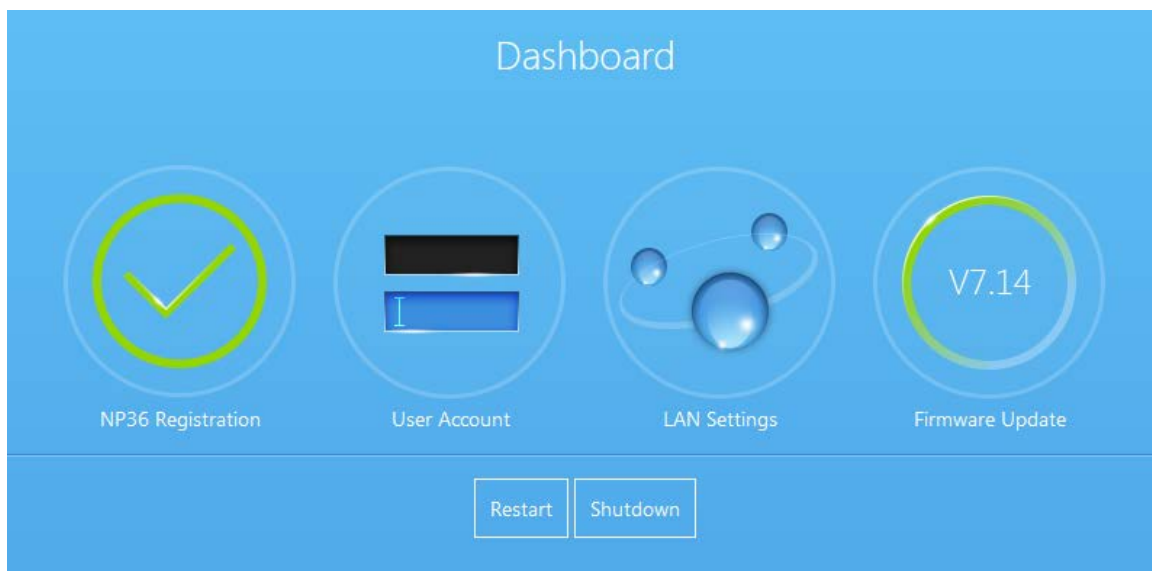

6. Click **NP36 Registration**.

- You will be redirected to a user agreement page. Click **I accept** to move on.

#### BAKPAK SUBSCRIPTION AGREEMENT

This BakPak Subscription Agreement ("Agreement") permits User (as defined below) to access and use the BakPak software-as-a-service product of Pakedge Device & Software, Inc. ("Pakedge") and sets forth the terms and conditions pursuant to which such product and service will be provided to User.

#### 1. SERVICE OFFERING

**1.1. Provision of the Product and Service.** Pakedge is making available for use by User the BakPak software-as-a-service product ("BakPak") on a fee-based subscription basis. User acknowledges that Pakedge may make changes to BakPak and the terms of this Agreement at any time, and Pakedge will update User accordingly. If User does not consent to such changes, User may immediately terminate this Agreement. A "User" means a registered user of BakPak with distinct log-in credentials who is authorized under the terms of this Agreement to access and use BakPak who is either (a) an authorized dealer of Pakedge products and services ("Dealer"); or (b) a customer of Dealer who is an end-user of such Pakedge products and services ("End-User"). Pakedge offers various services plans to access BakPak (each, a "BakPak Service Plan"), which User has selected pursuant to a separate order form ("Order Form") between User and Pakedge. In the case of an End-User, the particular BakPak Service Plan for that End-User may have been selected by Dealer.

**1.2. General Restrictions.** User shall not: (a) rent, lease, copy, provide access to or sublicense BakPak to a third party or use BakPak to provide a service to a third-party, other than a Dealer who may provide such rights to an End-User, (b) reverse engineer, decompile, disassemble, or otherwise seek to obtain the source code or APIs to BakPak, (c) modify BakPak or any Documentation, or create any derivative product from any of the foregoing, (d) remove or obscure any product identification, proprietary, copyright or other notices contained in BakPak (including any reports or data printed from BakPak), (e) incorporate BakPak into any other offering (whether software as a service or otherwise) except in the case of a Dealer with the prior consent of Pakedge, or (f) publicly disseminate information or analysis regarding the performance of BakPak.

Accept

Decline

- On the registration page you can register as either a **New User** or **Existing User**. By default, the **New User** form is shown.
- Click on **Existing User**.
- Enter the email address along with the password and give the Patroller a name. Click **Register**.
- You should be redirected to **mybakpak.com** on your new account.

## Accessing Mybakpak

To access your mybakpak account, enter [www.mybakpak.com](http://www.mybakpak.com) into your web browser and log in with your credentials. Once you have logged in, you will be redirected to the menu page. This page will display all of the functions that are registered to your MyBakPak account. You can now configure and use your Bakpak.

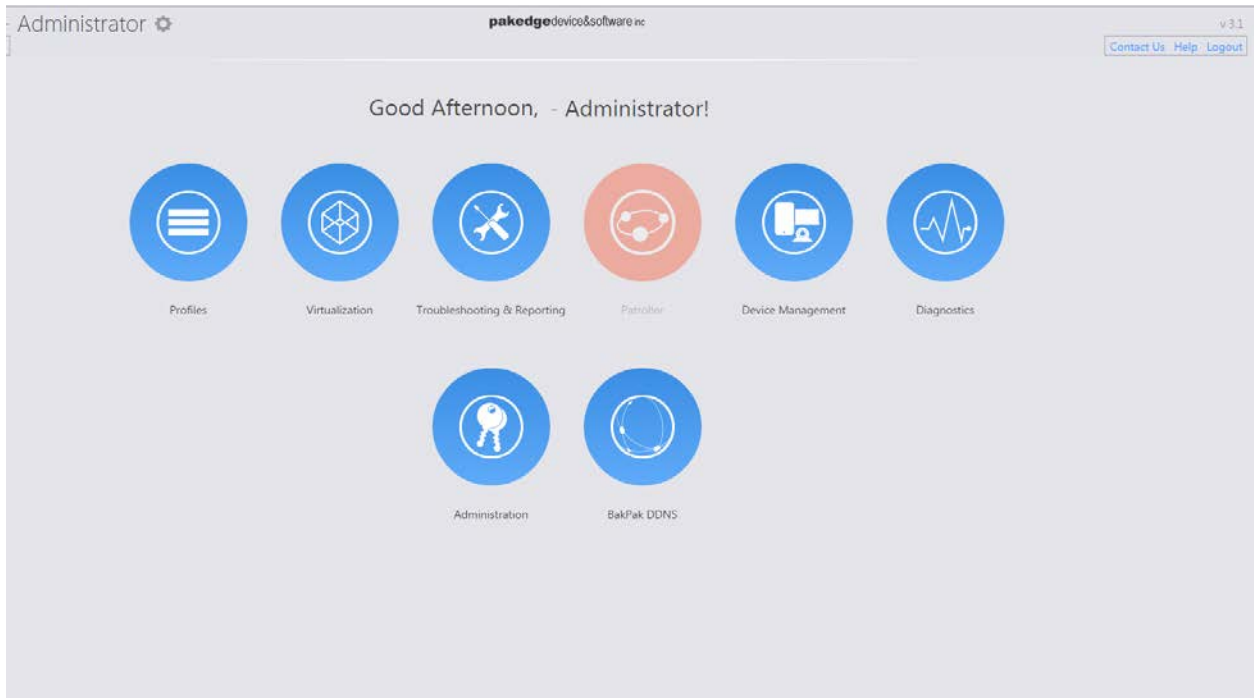

## Technical Support

If you need more information or technical assistance, please visit Pakedge Deal portal:  
<http://dealer.pakedge.com/portal/>

You can also contact Pakedge Technical Support Team by calling (650)385-8703, or emailing  
[support@pakedge.com](mailto:support@pakedge.com)

For non-technical inquires, call (650) 385-8701, or email [customerservice@pakedge.com](mailto:customerservice@pakedge.com)

## Limited Warranty

### Model NK-1

Congratulations on your purchase of a Pakedge Device & Software product! Pakedge designs and manufactures the finest home networking products. With proper installation, setup, and care, you should enjoy many years of unparalleled performance. Please read this consumer protection plan carefully and retain it with your other important documents.

This is a LIMITED WARRANTY as defined by the U.S. Consumer Product Warranty and Federal Trade Commission Improvement Act.

### **What Is Covered Under the Terms of This Warranty?**

**SERVICE LABOR:** Pakedge will pay for service labor by an approved Pakedge service center when needed as a result of manufacturing defect for a period of **three (3) years** from the effective date of delivery to the end user.

**PARTS:** Pakedge will provide new or rebuilt replacement parts for parts that fail due to defects in materials or workmanship for a period of **three (3) years** from the effective date of delivery to the end user. Such replacement parts are then subsequently warranted for the remaining portion (if any) of the original warranty period.

### **What Is Not Covered Under the Terms of This Warranty?**

This warranty only covers failure due to defects in materials and workmanship that occur during normal use and does not cover normal maintenance. This warranty does not cover any appearance item; any damage to living structure; failure resulting from accident (for example: flood, electrical shorts, insulation); misuse, abuse, neglect, mishandling, misapplication, faulty or improper installation or setup adjustments; improper maintenance, alteration, improper use of any input signal and/or power, damage due to lightning or power line surges, spikes and brownouts; damage that occurs during shipping or transit; or damage that is attributed to acts of God.

The foregoing limited warranty is Pakedge's sole warranty and is applicable only to products sold as new by Authorized Dealers. The remedies provided herein are in lieu of a) any and all other remedies and warranties, whether expressed, implied or statutory, including but not limited to, any implied warranty of merchantability, fitness for a particular purpose or non-infringement, and b) any and all obligations and liabilities of Pakedge for damages including but not limited to incidental, consequential or special damages, or any financial loss, lost profits or expense, or loss of network connection arising out of or in connection with the purchase, use or performance of the Product, even if Pakedge has been advised of the possibility of such damages.

**CAUTION: DAMAGE RESULTING DIRECTLY OR INDIRECTLY FROM IMPROPER INSTALLATION OR SETUP IS SPECIFICALLY EXCLUDED FROM COVERAGE UNDER THIS WARRANTY. IT IS IMPERATIVE THAT INSTALLTION AND SETUP WORK BE PERFORMED ONLY BY AN AUTHORIZED PAKEDGE DEALER TO PROTECT YOUR RIGHTS UNDER THIS WARRANTY. THIS WILL ALSO ENSURE THAT YOU ENJOY THE FINE PERFORMANCE YOUR PAKEDGE PRODUCT IS CAPABLE OF PROVIDING.**

### **Rights, Limits, and Exclusions**

Pakedge limits its obligation under any implied warranties under state laws to a period not to exceed the warranty period. There are no express warranties. Pakedge also excludes any obligation on its part for incidental or consequential damages related to the failure of this product to function properly. Some

states do not allow limitations on how long an implied warranty lasts, and some states do not allow the exclusion or limitation of incidental or consequential damages. In this case, the above limitations or exclusions may not apply to you. This warranty gives you specific legal rights, and you may also have other rights that vary from state to state.

**Effective Warranty Date**

This warranty begins on the effective date of delivery to the end user. For your convenience, keep the original bill of sale as evidence of the purchase date from your authorized dealer.

**Important- Warranty Registration**

Please register your product at [www.pakedge.com](http://www.pakedge.com). It is imperative that Pakedge knows how to reach you promptly if we should discover a safety problem or product update for which you must be notified. In addition, you may be eligible for discounts on future upgrades as new networking standards come about.

**To Obtain Service, Contact Your Pakedge Dealer.**

Repairs made under the terms of the Limited Warranty covering your Pakedge product will be performed by an Authorized Pakedge Service Center. These arrangements must be made through the selling Pakedge Dealer. If this is not possible, contact Pakedge directly for further instructions. Prior to returning a defective Product directly to Pakedge, you must obtain a Return Material Authorization number and shipping instructions. Return shipping costs will be the responsibility of the owner

pakedge device & software inc

 3847 Breakwater Avenue  
Hayward, CA 94545

 17011 Beach Blvd. Suite 600  
Huntington Beach, CA 92647

 (650) 385-8702

 [www.pakedge.com](http://www.pakedge.com)

 [sales@pakedge.com](mailto:sales@pakedge.com)