

KD-BYOD4K

4K KDPlay Wireless Presentation Gateway for PC, Mac, iOS and Android devices. Full and Multi-Presenter Viewing Modes. Screen Mirroring via LAN or WiFi with built-in Antenna. Power over Ethernet, HDMI and Analog Audio Output, USB Keyboard, Mouse, and Annotation Control



Key digital®

The Experts in Digital Video Technology and Solutions™

Table of Contents

About KD-BYOD4K	3
WiFi Direct Mode vs LAN Connection Mode	4
Quick Setup Guide	5
Cabling	5
Configure	6
Cast	11
Application Examples	14
Warranty Information	16
Product Warnings & Safety Instructions	16



Default IP Address: 192.168.13.1

Quick Setup Guide

Please visit www.keydigital.com for the latest product documentation, firmware, control drivers and software downloads. Product features and specifications are subject to change without notice

Always follow the instructions provided in this Operating Manual.

About KD-BYOD4K

KD-BYOD4K wireless presentation gateway for the KDPlay™ system enables presenters to cast content to their display or projector from their Windows or Mac laptops, iPads, iPhones, Android tablets, or phones via WiFi. Multiple attendees may cast simultaneously, encouraging teachers and students, trainers and participants, all to collaborate regardless of their connection type and without the hassle of wires. KD-BYOD4K features annotation, moderator management and touchscreen/mouse control for a true interactive experience. Easily load KDPlay™ application onto your laptop from the unit's web page or plug in the included KDPlay Flash™ to auto launch. Additional Flash™ may be purchased separately. Android users download the KDPlay™ app and iOS devices natively cast using AirPlay. KD-BYOD4K's dual network ports enable access via Employee and Guest network for easy internet access. KD-BYOD4K supports 4K output resolution as well as full-screen or auto sizing multi-presenter viewing modes

Key Features

- **Wireless Presentation Gateway:** Connect via WiFi to wirelessly cast content from device.
- **Bring Your Own Device:** Cast from Windows and Mac computers or Android devices using KDPlay™ software and app. Cast from iOS devices with AirPlay. Chromebook not currently supported
- **Multi-Presenter Mode:** Up to four presenters may share content at same time with auto adjusting screen layout
- **4K/UHD Source & Display:** Supports incoming signals and outputs at 4K/UHD for optimal clarity of spreadsheets and data content
- **Annotation and White Board:** Screen overlay tools for real-time collaboration. Screen captures are downloaded by QR code or in web browser
- **Extended Monitor:** Feature enables dual display setups such as video conference and presentation content view on side-by-side panels
- **Content Preview:** Collapsible dock on side of display provides preview thumbnail and name of paired devices
- **Touch Screen / Mouse Forwarding:** Connect touchscreen or mouse USB to unit to point and click on casted device
- **Moderator Management:** Administrator may start & stop device casting via web control page
- **Web GUI Administration:** Access unit setup, moderator, and security tools on web browser through LAN
- **Three-Level Security:** Including casting / pairing pin and Device-type permission options, AES-256 + RSA-1024 encryption
- **KDPlay™ Flash Included:** Software launcher with USB and USB-C connections allows Additional KDPlay™ Flash sold separately
- **Simultaneous Secure Dual Network:** Two network ports enable concurrent connection to Public and Private networks for ease of guest access without compromising security
- **Video Resolution:** Outputs 4K 3840x2160 @ 30fps or 60fps [4:2:0] 10.2Gbps, or 1920x1080p @ 60fps

- **Audio De-embedding:** Audio of the casted device is de-embedded at the unit's analog L/R audio connector for ease of integrating with audio amplification and mixing systems

WiFi Direct or LAN Connection

What Mode to Use? WiFi Direct or LAN Connection?

WiFi Direct Mode (Default) allows wireless devices direct access to the base unit using KD-BYOD4K's built-in WiFi access point. WiFi Direct Mode is the quickest way to begin casting to your KDPlay™ screen but is not recommended for applications that require internet connectivity.



LAN Connect Mode requires KD-BYOD4K be wired into your local network. Wireless devices access KD-BYOD4K via your existing external WiFi network therefore allowing users to stay connected to an internet enabled network(s). WiFi Direct mode is disabled when LAN Connect Mode is enabled.



Quick Setup Guide

Begin with KD-BYOD4K, the connected display / touch screen monitor, and all USB or HDMI extension devices turned off with power cables removed. Ensure that all desired functionality is achieved before installing.

Cabling

Cabling for WiFi Direct Mode

1. Connect KD-BYOD4K to an HDMI display.
2. (Optional) Connect mouse or touch screen monitor to USB 2.0 port if using content preview dock, annotation, or chalkboard tools. USB 3.0 and USB-C connections are available as well.
3. (Optional) Connect audio from L/R output to audio amplifier.
4. Connect power to KD-BYOD4K unit



Cabling for LAN Connection Mode

1. Connect KD-BYOD4K to an HDMI display.
2. Connect network cable from WiFi Router / Network Switch.
 - a. (Optional) Connect to KD-BYOD4K’s LAN 2 port to power the unit via PoE from a supported network switch
 - b. (Optional) You may connect KD-BYOD4K to two networks for concurrent access to KD-BYOD4K from devices on each network.
3. (Optional) Connect mouse or touch screen monitor to USB 2.0 port if using content preview dock, annotation, or chalkboard tools. USB 3.0 and USB-C connections are available as well.
4. (Optional) Connect audio from L/R output to audio amplifier.
5. Connect Power to KD-BYOD4K unit (if not using PoE as described in step 2a).





Configure

Configure for WiFi Direct Mode with Web UI

1. Connect to network named KD-BYOD4K-XXXX
2. Open web browser, and enter 192.168.13.1 in the address bar
3. Press the **ADMIN ACCESS** button at top-right of the page
4. Enter default password **admin**
5. Enter **NETWORK** menu and choose **Wireless** sub-menu
6. Enter the desired name (SSID) for KD-BYOD4K's WiFi network. The default network name is KD-BYOD4K-XXXX
7. Enter the desired password for KD-BYOD4K's WiFi network. The default password is **12345678**
8. **SAVE** changes

The screenshot shows a web browser window with the address bar containing '192.168.13.1'. A blue circle with the number '2' is overlaid on the address bar. The page header features the 'KDPLAY' logo on the left and 'ADMIN ACCESS' with a gear icon and a blue circle with the number '3' on the right. The main content area displays 'Welcome to KDPlay™' and 'Please Download KDPlay™ Application for Your System.' Below this are two download buttons: 'For Windows' (Requires Windows 7 or higher) and 'For macOS X' (Requires macOS 10 or higher). At the bottom, there are three numbered instructions: 1. Select the download file for your system and download. 2. Run the installer and follow installation steps. 3. Open KDPlay™ on your computer and stream your media.



ADMIN ACCESS 

Welcome to **KD-BYOD4K**, Wireless Presentation Switcher

Please Enter Device Password: 

4

LOG IN



For Windows
Requires Windows 7 or higher.



For macOS X
Requires macOS 10 or higher



For Android
Requires Android 5.0 or higher.



Operation Manual
Requires PDF Viewer.



LOGOUT 

Network Wireless Settings

5 NETWORK

- > Network Mode
- > **Wireless**
- > Ethernet (LAN)

DISPLAY & AUDIO

SYSTEM

SECURITY

F/W UPDATE

DEVICE INFO

WiFi Direct Mode

LAN Connection Mode

Network Name (SSID): **6**

Security: WPA/WPA2 - Personal (Recommended)

Frequency: 2.4 Ghz 5 Ghz

Auto Change Password:

Password: **7**

Channel Width: [text]

Channel:

SAVE **8**

Configure for LAN Connection Mode with Web UI

1. Connect to network named KD-BYOD4K-XXXX
2. Open web browser, and enter 192.168.13.1 in the address bar
3. Press the **ADMIN ACCESS** button at top-right of the page
4. Enter default password **admin**
5. Enter **NETWORK** menu and choose **Network Mode** sub-menu
6. Choose **LAN Connection Mode** and confirm to apply.
7. Press **SAVE** and KD-BYOD4K will reboot in the new mode
8. Enter the **Wireless** sub-menu and the **LAN Connection Mode** tab
9. Choose **2.4 Ghz or 5 Ghz** frequency and press **WIRELESS SCANNER** to begin scanning for the WiFi Network that you have connected the KD-BYOD4K unit to.
10. Choose your desired WiFi Network and press **SAVE**
11. Enter the WiFi Password and press **CONNECT**. Press **SAVE** and verify **Connection Status**
12. (Optional) To set a desired static IP address to KD-BYOD4K, enter the Ethernet LAN sub-menu. The default IP address setting for LAN Connection Mode is DHCP / Obtain IP Address Automatically. Press **SAVE** to apply new settings.

The screenshot displays the 'Network Mode Settings' page in the KOPLAY web interface. On the left, a sidebar menu includes 'NETWORK', 'DISPLAY & AUDIO', 'SYSTEM', 'SECURITY', 'F/W UPDATE', and 'DEVICE INFO'. The 'NETWORK' menu is expanded to show 'Network Mode', 'Wireless', and 'Ethernet (LAN)'. A blue circle with the number '5' highlights the 'Network Mode' option. The main content area shows the current network mode as 'WiFi Direct Mode' and the device name as 'My Conference Room'. Two modes are available: 'WiFi Direct Mode' (disabled) and 'LAN Connection Mode' (selected). The 'LAN Connection Mode' option is highlighted with a blue circle containing the number '6'. Below the 'LAN Connection Mode' option, a diagram shows the 'KD-BYOD4K' unit connected to a 'My WiFi Router' via a LAN cable, which then connects to various devices. A blue circle with the number '7' highlights the 'SAVE' button at the bottom right.

NETWORK

- > Network Mode
- > **Wireless** 8
- > Ethernet (LAN)

Network Wireless Settings

WiFi Direct Mode | LAN Connection Mode

Frequency: 2.4 Ghz 5 Ghz

WIRELESS SCANNER 9

SSID: --

Password: **CONNECT**

Connection Status: No connection

SAVE

NETWORK

- > Network Mode
- > **Wireless** 10
- > Ethernet (LAN)

Available WiFi Networks

RESCAN ↻

ID	SSID	Signal
<input checked="" type="radio"/> 1	KDS-LAB-TEST	📶
<input type="radio"/> 2	Lab_Extreme	📶
<input type="radio"/> 3	Cisco11943	📶
<input type="radio"/> 4	LinksysE900Recording	📶
<input type="radio"/> 5	KDQC_Station1	📶
<input type="radio"/> 6	Verizon-791L-749A	📶
<input type="radio"/> 7	04PX1	📶
<input type="radio"/> 8	49MSG	📶
<input type="radio"/> 9	Keydigital	📶
<input type="radio"/> 10	CompassTrainingRacks	📶

SAVE

KOPLAY LOGOUT

NETWORK

- > Network Mode
- > **Wireless**
- > Ethernet (LAN)

DISPLAY & AUDIO

SYSTEM

SECURITY

F/W UPDATE

DEVICE INFO

Network Wireless Settings

WiFi Direct Mode | LAN Connection Mode

Frequency: 2.4 Ghz 5 Ghz

WIRELESS SCANNER

SSID: KDS-LAB-TEST

Password: 12345678 **11** **CONNECT**

Connection Status: **Connected**

SAVE **11**

KOPLAY LOGOUT

NETWORK

- > Network Mode
- > Wireless
- > **Ethernet (LAN)**

DISPLAY & AUDIO

SYSTEM

SECURITY

F/W UPDATE

DEVICE INFO

Network Ethernet (LAN) Settings

LAN 1 | LAN 2

Obtain Address Automatically Use the following IP address:

IP Address: 192.168.1.100 **12**

Subnet Mask: 255.255.0.0

Default Gateway: 192.168.1.1

DNS 1: 192.168.1.20

DNS 2:

MAC Address: 60:89:B1:37:10:01

SAVE

Cast

1. Power on connected HDMI display and select the appropriate HDMI input connection. All instructions are displayed on KD-BYOD4K's Home Screen

2. Casting from PC / Mac computer:

- a. Ensure that you are connected to appropriate WiFi network, as instructed on Home Screen.
- b. Open web browser, and enter KD-BYOD4K's IP Address, as displayed on Home Screen on your display / projector.
- c. On Welcome Page, press button to download *KDPlay™* software for Windows or macOS X.
- d. Run the *KDPlay.exe* file to open *KDPlay™* software.
- e. Choose desired *KDPlay* screen you wish to cast to. Press **CONNECT** button.
- f. Enter the KD-BYOD4K device's password, as displayed on Home Screen.
- g. Press **CONNECT** button. You are now paired with the KD-BYOD4K device, but not yet Casting.
- h. Press **START MIRRORING** to begin casting your content.
- i. Press the GEAR ICON to enter the Settings for Volume, Extended Display, and more

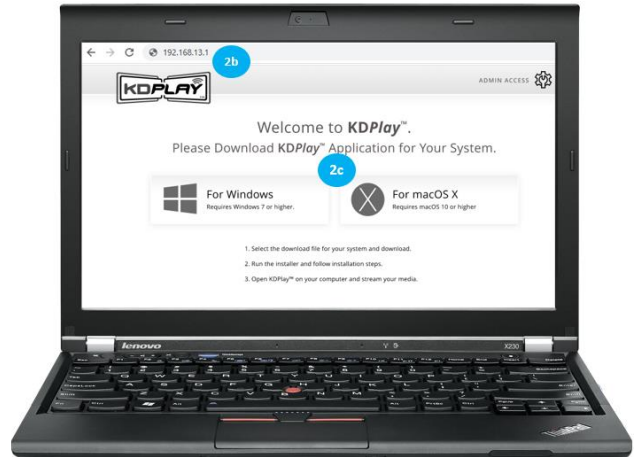

3. Casting with *KDPlay* Flash from PC / Mac computer:

- a. Ensure that you are connected to appropriate WiFi network, as instructed on Home Screen.
- b. Insert *KDPlay* Flash drive into computer. *KDPlay* software will auto launch
- c. Follow step 2e, 2f, 2g, and 2i above



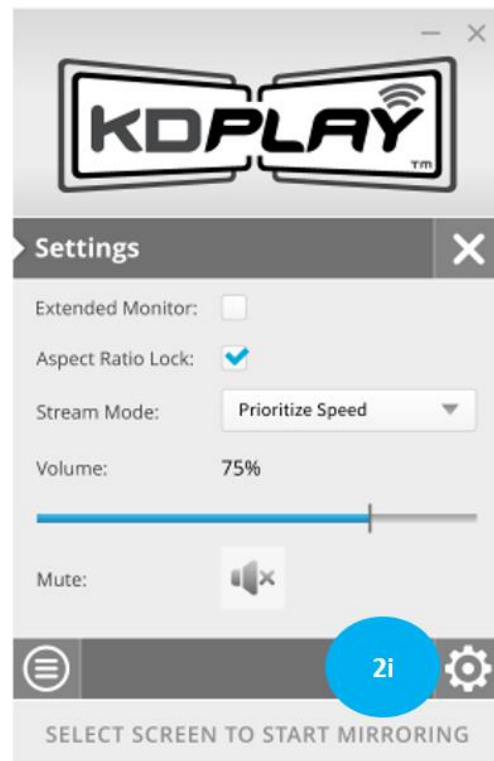
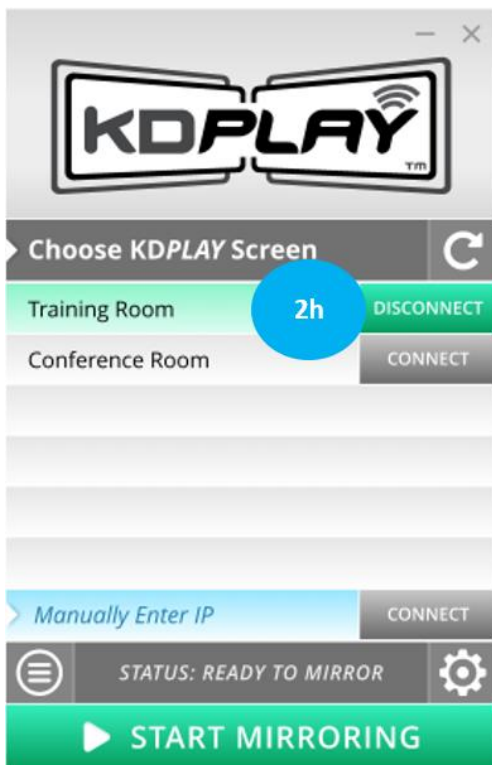
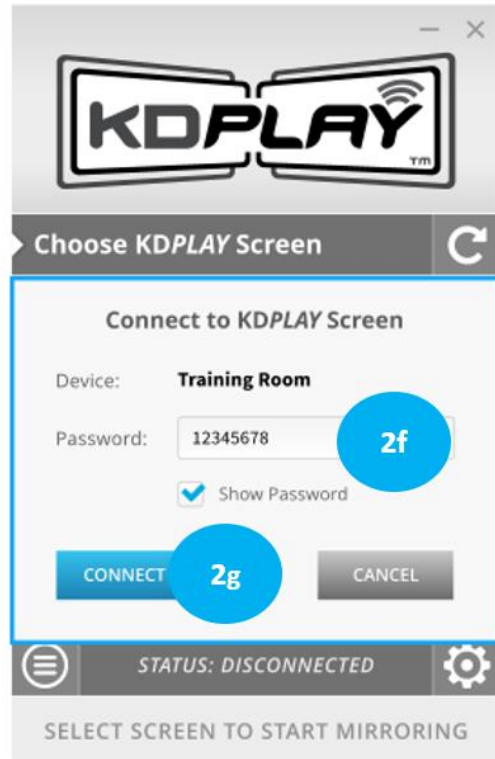
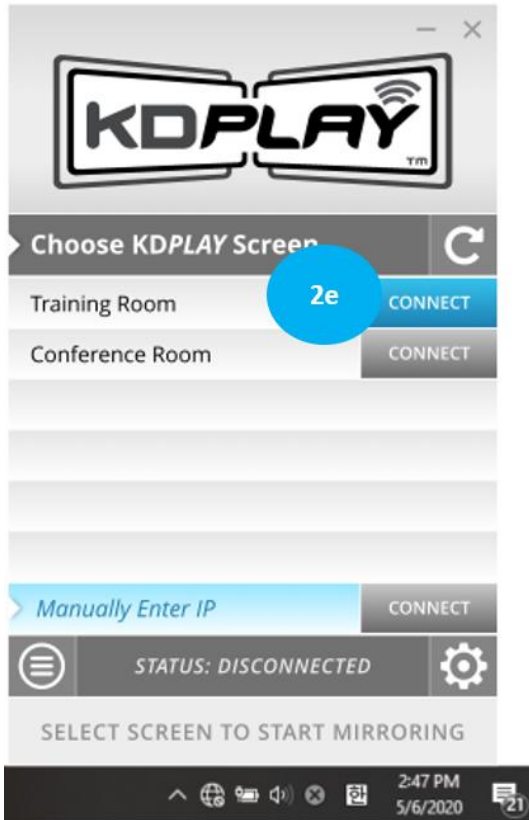

4. Casting from iOS Device:

- a. Ensure that you are connected to appropriate WiFi network, as instructed on Home Screen
- b. Open **Control Center** on iOS Device
- c. Choose **Screen Mirroring**
- d. Choose your KD-BYOD4K device you wish to cast to

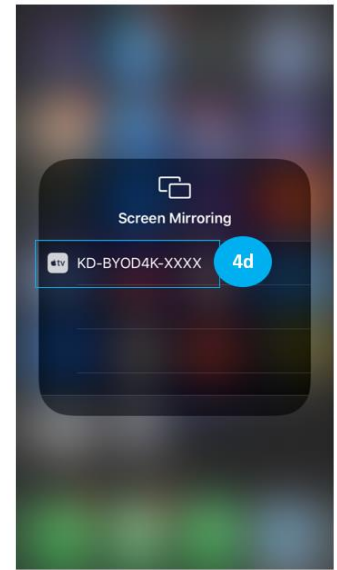
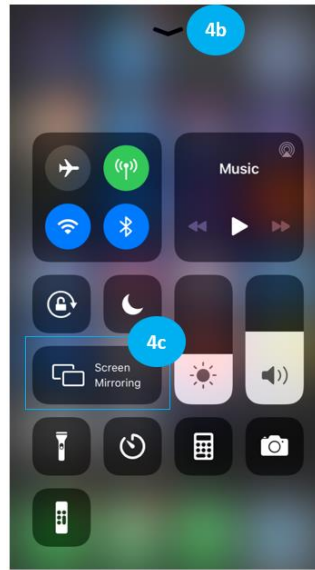

5. Casting from Android device:

- a. Open **Google Play** and download **KDPlay™** app
- b. Ensure that you are connected to appropriate WiFi network, as instructed on Home Screen.
- c. Run **KDPlay™** app
- d. Choose desired **KDPlay** screen you wish to cast to.
- e. Enter the KD-BYOD4K device's password, as displayed on Home Screen.
- f. Press **CONNECT** button. You are now paired with the KD-BYOD4K device, but not yet Casting.
- g. Press **START MIRRORING** to begin casting your content.

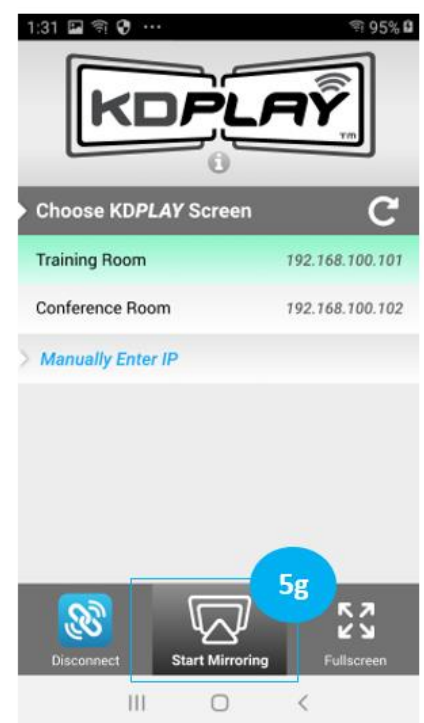
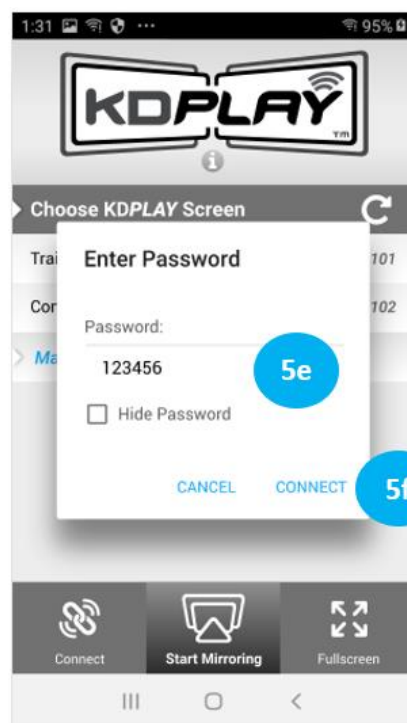
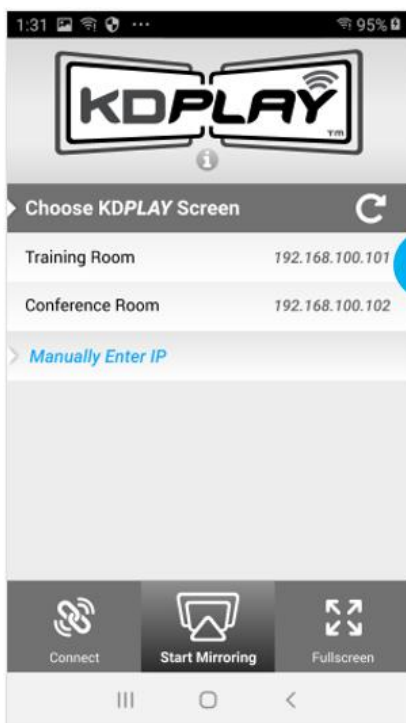

Application Examples

WiFi Direct Mode

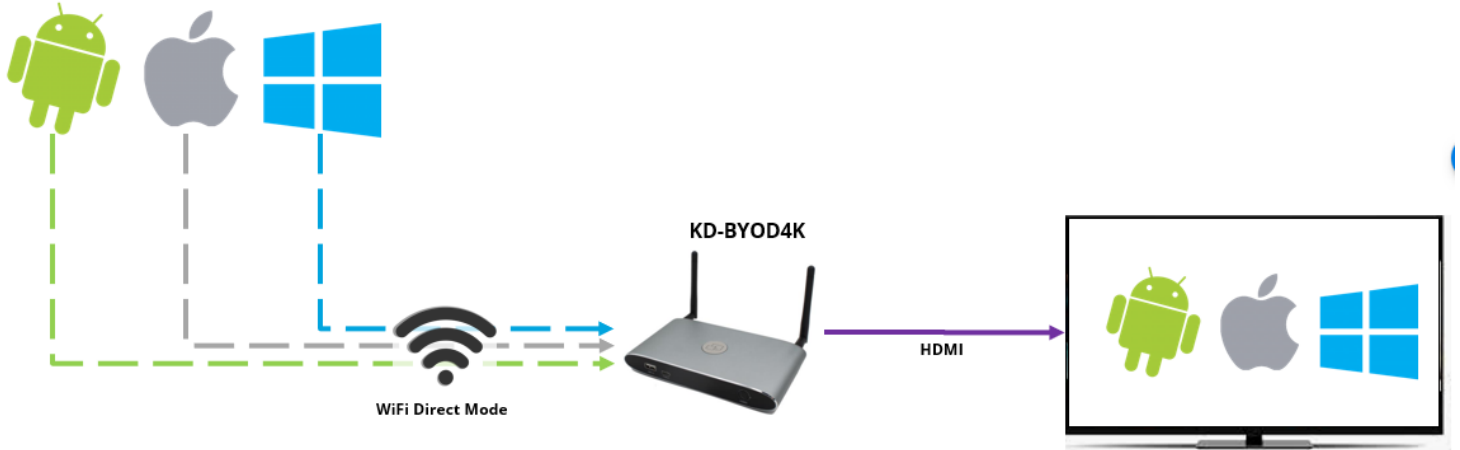

Touchscreen Annotation in LAN Connection Mode

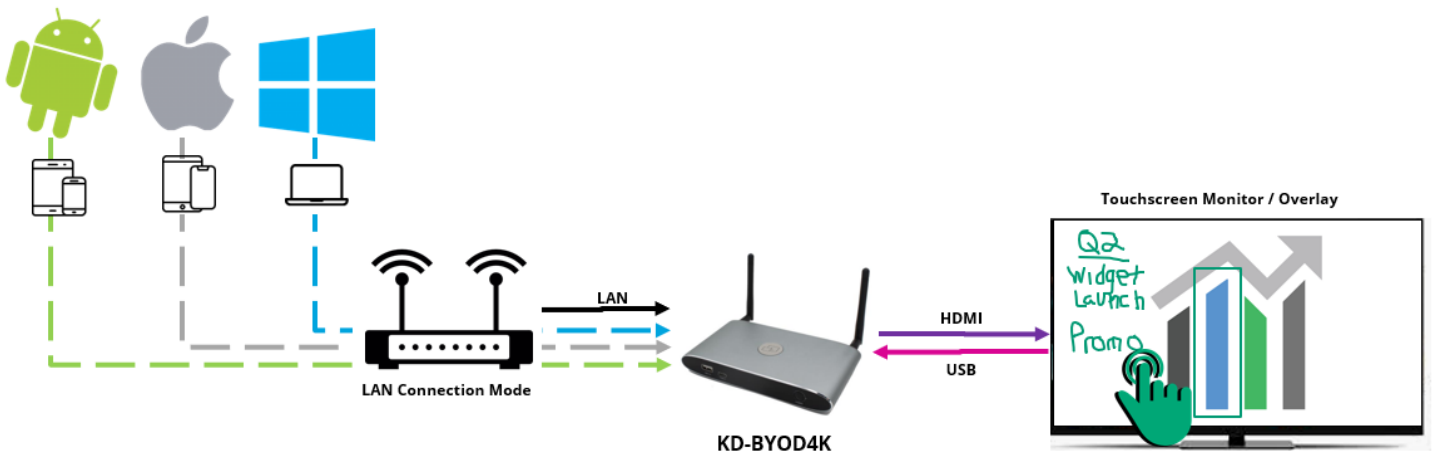

Audio De-Embedding and USB Extension

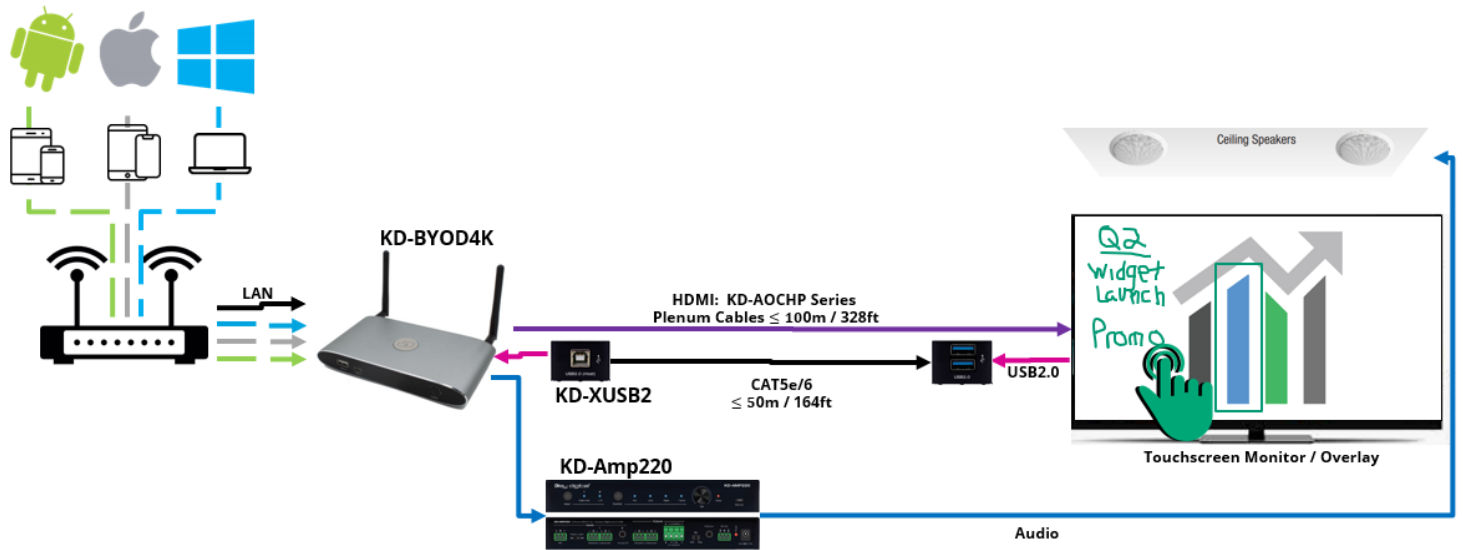

Integration with Key Digital Complete Presentation Solution

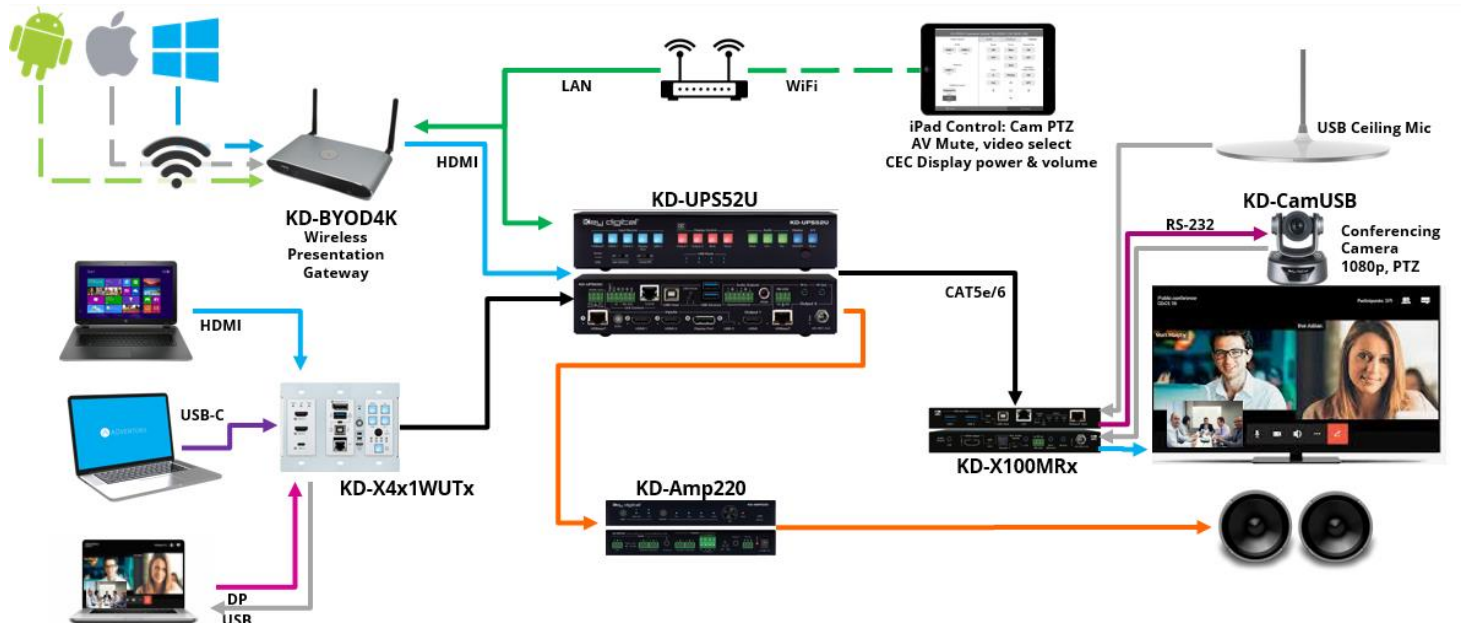

Warranty Information

All Key Digital® products are built to high manufacturing standards and should provide years of trouble-free operation. They are backed by a Key Digital Limited 3 Year Product Warranty Policy.

<http://www.keydigital.com/warranty.htm>

Product Warnings & Safety Instructions



Important Product Warnings:

1. Connect all cables before providing power to the unit.
2. Test for proper operation before securing unit behind walls or in hard to access spaces.
3. If installing the unit into wall or mounting bracket into sheet-rock, provide proper screw support with bolts or sheet-rock anchors.



Safety Instructions:

Please be sure to follow these instructions for safe operation of your unit.

1. Read and follow all instructions.
2. Heed all warnings.
3. Do not use this device near water.
4. Clean only with dry cloth.
5. Install in accordance with the manufacturer's instructions.
6. Do not install near any heat sources such as radiators, heat registers, stoves, or other apparatus (including amplifiers) that produce heat.
7. Only use attachments/accessories specified by the manufacturer.
8. Refer all servicing to qualified service personnel. Servicing is required when the device has been damaged in any way including:
 - Damage to the power supply or power plug
 - Exposure to rain or moisture



Power Supply Use:

You MUST use the Power Supply provided with your unit or you VOID the Key Digital® Warranty and risk damage to your unit and associated equipment.