

KD-MLV4x4Pro

4x4 4K HDMI seamless matrix with multi-view tiling, 4 Rx units. Features independent AV routing, mirrored HDMI and UHDoTP outputs.

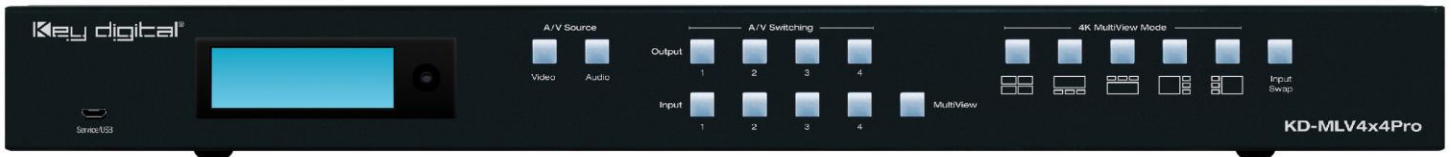

4K MultiView Modes



x4



Key digital®

Engineered for Your Success™

Table of Contents

About KD-MLV4X4PRO	3
Quick Setup Guide	5
Connect	5
Configure	5
Control	8
Application Example	11
KD-MLV4x4Pro Connections and LEDs	11
KD-EXMLVRx Connections and LEDs	15
Front Panel Control & LCD	17
IR Remote Control	19
Web User Interface	20
TCP/IP and RS-232 Commands	23
Text Overlay	28
Integrating with AV over IP Systems	29
Specifications	30
Warranty Information	31
Product Warnings & Safety Instructions	31



Quick Setup Guide

Please visit www.keydigital.com for the latest product documentation, firmware, control drivers and software downloads. Product features and specifications are subject to change without notice

Always follow the instructions provided in this Operating Manual.

About KD-MLV4X4PRO

Key Digital's KD-MLV4x4Pro is a 4 HDMI input with 4 HDMI + 4 UHDoTP mirrored output matrix, multi-view tiling video processor, and independent audio routing.

KD-MLV4x4Pro is perfect for applications like Sports & Gaming Caves, Bar & Restaurant, Corporate AV, House of Worship, Entertainment Centers, Museums, and E-Sports. Or, simply use KD-MLV4x4Pro to deliver wow-factor to your distributed video systems.

The multi-view tiling processor enables users to view up to 4 video sources at the same time on a display in different default and custom layout presets. Custom and multi-view layouts include the option to layer content, applying desired bezel frame width and color.

4K / UHD content up to 3840 x 2160p 4:2:0 at 60fps is supported and when in full-screen mode switching from source to source is completely seamless. Integrate with legacy displays or projectors by applying 4K to 1080p or 720p down-conversion as needed. Each output has mirrored HDMI and UHDoTP connections, for a total of 8 possible connected displays. Four (4) Receiver units are included, and they get their power from the main unit for ease of installation.

KD-MLV4x4Pro supports independent audio routing with de-embedding on analog balanced/un-balanced and digital optical connections and surround formats up to 5.1 Dolby® / DTS™. Audio from any source may be selected while in multi-view mode.

For ease of installation and viewing, KD-MLV4x4Pro features 9 built-in test patterns and optional on-screen display text for each source. KD-MLV4x4Pro supports HDCP 2.2, provides EDID handshaking to the connected source from a library of 8 AV profiles or a copy of any connected display's EDID file. IR from a control system may be input at KD-MLV4x4Pro and extended to control the displays connected to the KD-EXMLVRx units.

Key Features

- **Multi-view Tiling Processor:** Simultaneously watch multiple sources on a single screen
- **Full-Screen Mode:** View full-screen content on any display
- **Multi-View Mode:** Choose from 5 default layouts or create custom presets. The active multi-view layout is distributed to any display currently in multi-view mode
- **Seamless Switching:** Un-interrupted screen transitions during source selection while in full-screen mode
- **Built-In UHDoTP Tx with PoC:** 4 included KD-EXMLVRx units are powered by KD-MLV4x4Pro
- **Mirrored Outputs:** Simultaneously active HDMI + UHDoTP connections per output show same AV signal at same time for a total of 8 possible displays connected
- **Independent Audio Matrix:** Audio output ports may be routed separately from HDMI & UHDoTP ports. Audio from any source may be selected while in multi-view mode.
- **Video Resolution:** Up to 3840 x 2160p 4:2:0 60fps supported on inputs and 3840 x 2160 4:4:4 at 30fps on outputs

- **Signal Extension over CAT:**
 - **4K/UHD:** Up to 35m (115ft) using CAT5e/6, up to 40m (131ft) using CAT6A STP
 - **1080p:** Up to 50m (164ft) maximum, up to 60m (197ft) using CAT6A STP
 - **Minimum:** 5m (17ft) CAT5e/6 cable length required for all resolutions
- **Text Overlay:** Assigned name of each source may be displayed in each window. 16 Characters maximum with variable sizing and location settings.
- **4K Down-Convert:** Integrate 4K sources with legacy 1080p & 720p displays
- **Image Layering:** Stack images with customizable priority settings per output
- **Window Border:** Choose window bezel width and coloring
- **HDCP 2.2 Licensing:** Fully licensed and compatible with HDCP 2.2
- **Built-In Test Patterns:** 9 selectable test screens help expedite installation, verify cabling & functionality
- **IR Two-Way:** Extend IR via Rx units to control displays or collect IR from remote to control a source at matrix.
- **Web UI:** Control AV routing and other basic functions from any web browser
- **Audio De-Embed:** 6 pin balanced / un-balanced and digital optical outputs
- **Dolby Digital® & DTS™ Audio:** Supports 2-channel and multi-channel surround formats up to 5.1 Dolby® / DTS™
- **Full Buffer System™:** Manages TMDS re-clocking / signal re-generation, HDCP authentication to source & display, and EDID handshake to source
- **EDID Management:** Internal library with 8 EDID AV handshakes per input, in addition to ability to copy from any connected display / output
- **TMDS Re-clocking:** Supports long HDMI connectivity using Key Digital® HDMI cables
- **Deep Color Support:** Up to 8 bits/color
- **Control:** Front panel buttons, IR, RS-232, TCP-IP and Web Control
- **Key Digital® App Ready:** Can be controlled over TCP/IP via Key Digital® App
- **Control System Support:** Key Digital® app ready. Key Digital Management Software™ Pro (KDMS™ Pro) ready, Compass Control® Pro ready. Fully controllable by all IR, RS-232, and TCP/IP supported control systems via open API.

Accessories

- **(1) Power supply**, 12V 5A screw-type, model KDPS60W12VC. Qty 1
- **(1) IR Remote Control**, model KDRMLV4x4, Qty 1
- **(4) UHDoTP Rx units**, model KD-EXMLVRx
- **(4) IR Emitters** with 3.5mm mono end. 6ft.
- **(4) IR Sensors** with 3.5mm 4 conductor end. 6ft.
- **(4) 6-pin Phoenix connector** for audio, blue
- **(1) 6-pin Phoenix connector** for unit control
- **(1) USB data cable**, Micro to A, 6ft, USB 2.0
- **(2) Rack ears**

Quick Setup Guide

Begin with the KD-MLV4X4PRO and KD-EXMLVRx units, all source, display devices, audio system, and any other connected peripherals powered off.

Connect

1. **Connect video sources** into the HDMI input ports
2. **Connect video displays / projectors** to the HDMI output ports on the main and Rx units
3. **Connect CAT5e/6 cabling** from the main unit's UHDoTP outputs to the RX unit's UHDoTP input
4. **Connect audio** using the digital or analog outputs ports located on the main unit.
5. **Connect Control System.** For KD-App control and/or IP control from a control system or PC, connect TCP/IP port to network. RS-232 and IR control may also be utilized
6. **(Optional) Connect IR to / from Rx units**
 - a. **If controlling display/projector:** Connect from control system into IR In/Out ports of main unit and connect IR emitter to the IR Out port of the respective Rx unit (1→1 ... 4→4).
 - b. **If controlling video source:** Connect IR sensor to Rx unit to collect line-of-site IR from a remote. Connect IR emitter to the respective IR In/Out port of main unit (1→1 ... 4→4).
7. **Connect power.** Screw-in power supply to the KD-MLV4X4PRO unit, and then connect power to outlets.
8. **Power on** sources, displays, and audio systems to begin use.

Configure

Configure KD-MLV4X4PRO with Key Digital Management Software Pro (KDMS Pro). Download [HERE](#)

1. Connect to KD-MLV4X4PRO from your PC using the USB micro port on the face of the unit
2. Open the KDMS Pro software and perform a USB scan (2a). Choose "NO" and Start Scan when the USB Device Scan prompt appears (2b)
3. Choose the detected device from the Devices window (fig. 3)
4. Enter the desired unit name (4a), IP address (4b) and IP gateway (4c) settings for the unit
5. Save (5)
6. Select the desired EDID handshake for each video source (6)
7. (Optional) Set the direction of the IR signal. The default setting / signal flow is IR In on the MLV4x4Pro and IR out on the Rx units to control the connected displays/projectors.
8. Set the desired Input/Output names by entering the Input/Output Settings section of the properties window and selecting the Change Input/Output Name button (7a), selecting the desired input/output (7b), entering the desired name (7d) and pressing the Change button (7d).

- Your unit is now ready to control from the web UI, KDMS Pro control panel, KD-App, or by professional control system. Full access to all settings/commands is achieved via terminal session using Tera Term or PuTTY software.

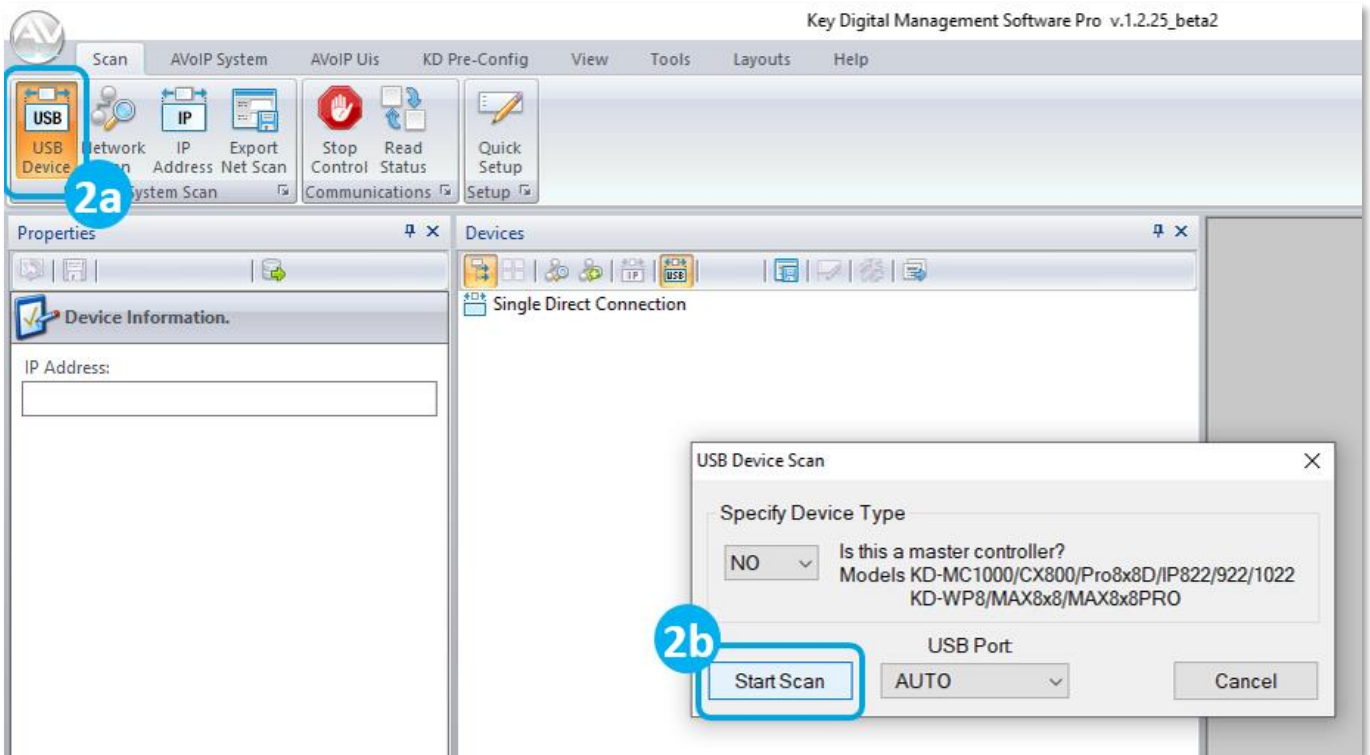

Key Digital Management Software Pro v.1.2.25_beta

Scan | AVoIP System | AVoIP Uis | KD Pre-Config | View | Tools | Layouts | Help

USB Device | Network Scan | IP Address Net Scan | Export Net Scan | Stop Control | Read Status | Quick Setup

Device / System Scan | Communications | Setup

Properties (5)

Update Changed Device properties

Device Name: **Video Router** (4a)

Main F/W Version: 1.16

Read | Update

Network Settings

MAC Address: 60:89:B1:23:20:F6

IP Address: **192.168.1.239** (4b)

IP Mask: 255.255.255.000

Gateway: **192.168.1.001** (4c)

Port: 0023

Devices

Single Direct Connection

USB (COM6)

Switchers

192.168.100.239 KD-MLV4x4Pro "Video Router" (3)

EDID Settings

Input 1	4K 60 10G 2ch
Input 2	1080p 2ch
Input 3	4K 60 DTS/Dolby
Input 4	4K 60 10G 2ch

(6)

Properties

1.16

Read | Update

Network Settings

Video/Audio Settings

Inputs/Outputs Settings

Input 1: HDMI 1, Link= Off
 Input 2: HDMI 2, Link= Off
 Input 3: HDMI 3, Link= Off
 Input 4: HDMI 4, Link= Off

Output 1:HDMI, In= 1, Link= Off

Change Input/Output Name (7a)

Devices

Single Direct Connection

USB (COM6)

Switchers

192.168.001.239 KD-MLV4x4Pro "Video Router"

Change Input/Output Name (7b)

Input/Output: Input 1 (7b)

Name: DirecTV 1 (7c)

Change (7d) | Cancel

Control

Option 1: Control via Remote Control

Refer to IR Remote Control section for complete control options via IR.

- Switching HDMI AV + External Audio together
 1. R1 button (section E)
 2. Output button (section B)
 3. Input button (section D)
- Select multi-view layout for all multi-view zones
 1. R1 button (section E)
 2. Layout 1-9, using Device Select buttons (section F)
 - 1-5 = same as layouts 1-5 on front panel and pictured below
 - 6-9 = custom layouts
- Audio Selection in Multi-View mode
 1. Audio button (section A)
 2. MV button (section C)
 3. Input button (section D)

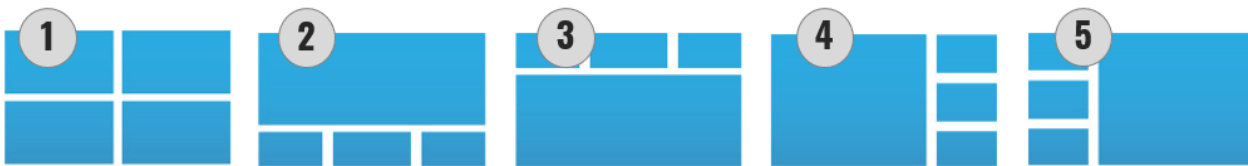

Option 2: Control via KD-App, KDMS Pro™

KD-MLV4x4Pro is controllable by Key Digital's user-friendly [iOS App](#) (downloadable in the App Store) or Key Digital® Management Software™ Pro ([downloadable here](#)).

1. Connect and Configure your KD- MLV4x4Pro as described in the Connect & Configure sections
2. Download and open KD-App and/or KDMS™
3. Ensure the iOS device and/or PC computer are on the same network with KD- MLV4x4Pro
4. Perform a network scan in the KD-App/KDMS™
5. Select and control the selected KD- MLV4x4Pro
6. To enter KDMS Pro end-user mode, key CTRL + ALT + N after selecting the unit in the devices tree.



Option 3: Control via web UI

Access KD-MLV4x4Pro's web UI from any phone, tablet, or PC. The web UI shows the input, output, and unit name, for a user-friendly experience.

1. Connect and Configure your KD- MLV4x4Pro as described in the Connect & Configure sections
2. Ensure the PC, phone, or tablet are on the network with KD- MLV4x4Pro
3. Enter IP Address of KD-MLV4x4Pro unit into the web browser search bar
4. Enter the password. Default password is "admin"
5. Use the web UI to control video routing (5a) and select multi-view for each output (5b), choose audio sources in multi-view mode (5c) or for independent audio routing (5d).

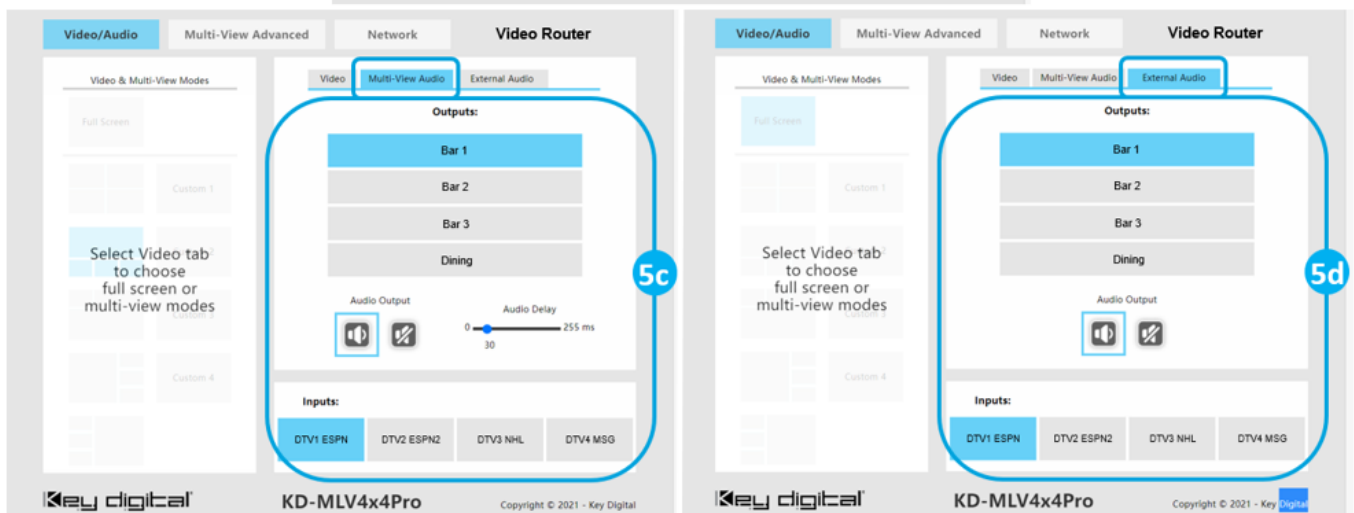
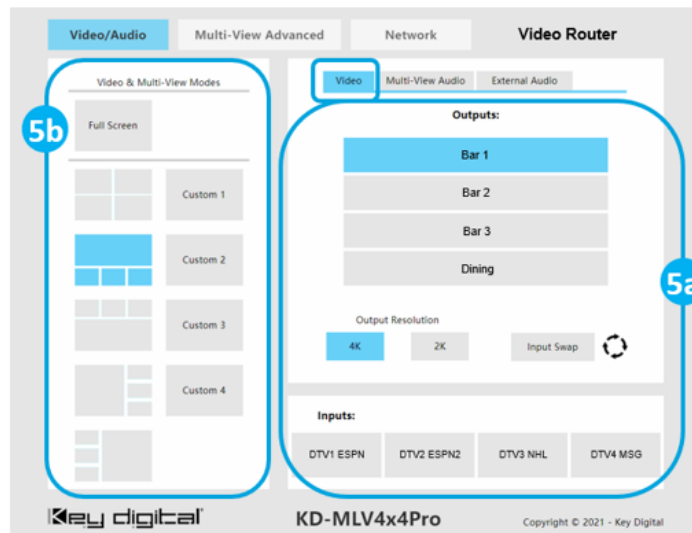
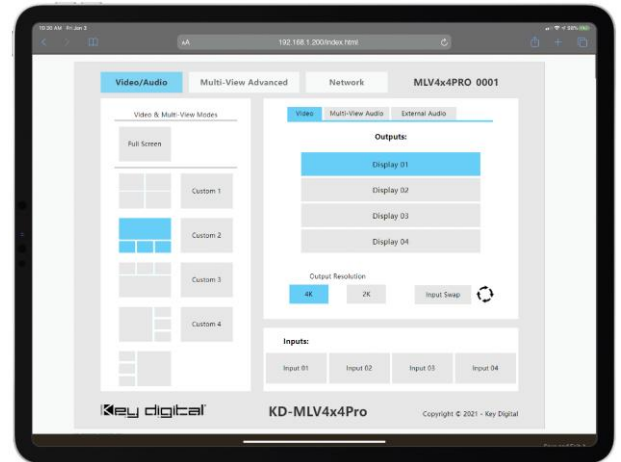

Option 4: Control via professional control system

KD-MLV4x4Pro allows control over serial interface for bi-directional communication.

- **For RS-232 control** use pins 4, 5, and 6 of the Unit Control port. Baud Rate is 57,600
- **For TCP/IP control** the default static IP address is 192.168.1.239, with port 23.

Default static IP address:
192.168.1.239, port 23

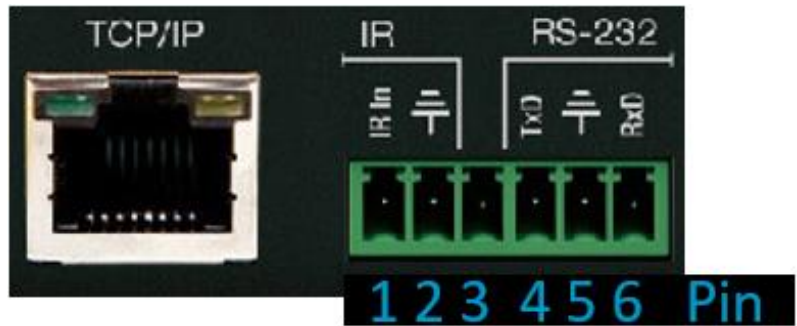

- KD-MLV4x4Pro supports KD’s standard matrixing protocol, so if you have controlled a KD matrix with a third-party control system before, you will likely have success with the same driver/module.
 - Switching HDMI AV + External Audio together**
 - SPOxxSlyy xx = output (01-04), yy = input (01-04, 05 = multi-view)
 - Switching HDMI AV Only**
 - SPOxxSByy xx = output (01-04), yy = input (01-04, 05 = multi-view)
 - Switching External Audio only**
 - SPOxxSAyy xx = output (01-04), yy = input (01-04)
- A carriage return is required at the end of each string. See the TCP/IP and RS-232 Commands section for full command set and protocol.



Test for proper operation of the unit and cables in your system before permanently securing the unit for final installation. Ensure that you leave enough ventilation space to provide sufficient airflow and cooling

Application Example

Bar / Restaurant with 8 mirrored displays in multi-view & full-screen modes, audio de-embed to amplifiers, and web UI control.

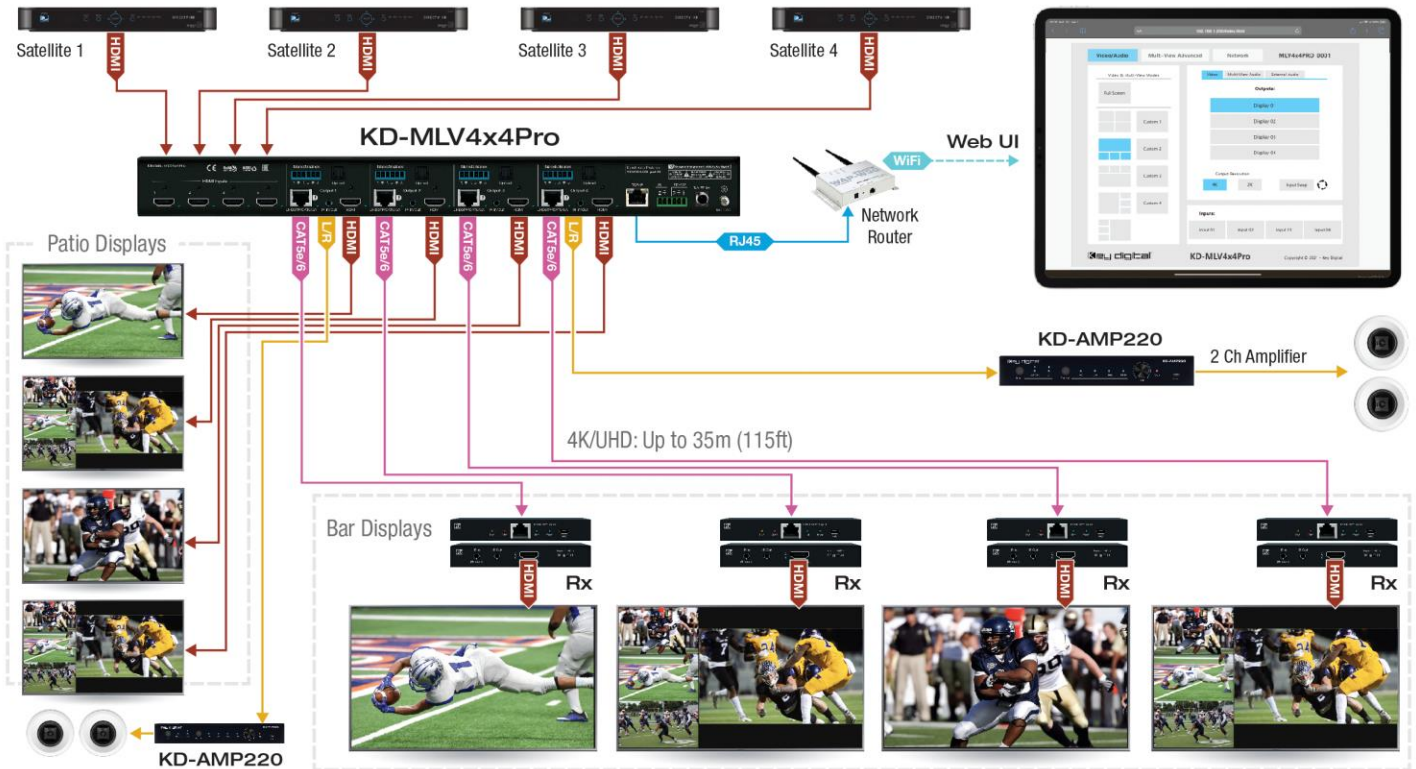

KD-MLV4x4Pro Connections, and LEDs

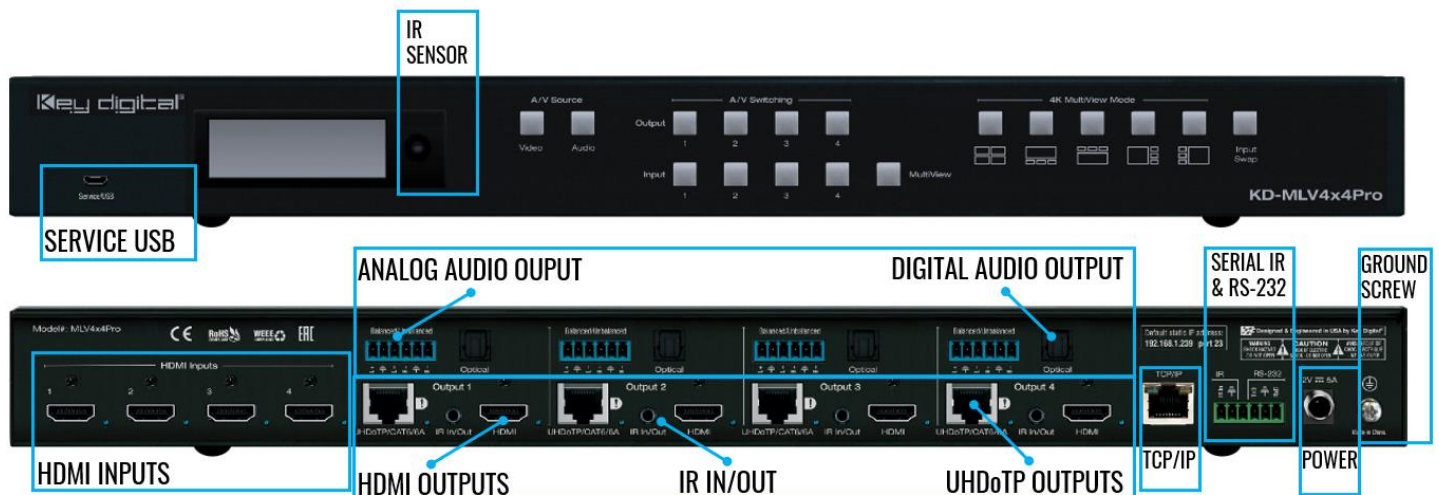

HDMI Inputs (4): Using an HDMI cable, connect your HDMI sources.

- Supports up to UHD/4K @ 60fps [4:2:0], 8 bit color, 10.2Gbps maximum bandwidth
- Compliant with HDMI 2.0, HDCP 2.x and previous
- Supports surround audio formats including Dolby®, DTS™ (formats up to 5.1 / 6.1)
- Does not support HDR, CEC, ARC, or 3D
- For Display Port sources use active DP to HDMI converter
- **Blue** Link LED to the right of port illuminates with an active HDMI signal from source.

HDMI Outputs (4): Using an HDMI cable, connect your HDMI displays.

- Supports up to UHD/4K @ 30fps [4:4:4], 8 bit color, 10.2Gbps maximum bandwidth
- Compliant with HDMI 2.0, HDCP 2.x and previous
- Supports surround audio formats including Dolby®, DTS™ (formats up to 5.1 / 6.1)
- Does not support HDR, CEC, ARC, or 3D
- Output resolution of 4K @ 30fps, 1080p @ 60fps, or 720p @ 60fps may be selected per output using KDMS Pro software or by sending command via TCP/IP or RS-232
- For Display Port monitors use active HDMI to DP converter
- **Blue** Link LED to the right of port illuminates with active Hot Plug Detection voltage from the display.

UHDoTP Output (4): Connect a CAT5e/6 cable to the Rx unit's UHDoTP Input port using CAT5e/6 cabling in 568-B termination.

- Supports up to UHD/4K @ 30fps [4:4:4], 8 bit color, 10.2Gbps maximum bandwidth
- Compliant with HDMI 2.0, HDCP 2.x and previous.
- Distance performance:
 - UHD/4K: Up to 115ft (35m) using CAT5e/6, up to 40m (131ft) using CAT6A STP
 - 1080p: UP to 164 ft (50m) using CAT5e/6, up to 60m (197ft) using CAT6A STP
- Supports Dolby®, DTS™ (5.1 / 6.1 formats max)
- Does not support HDR, CEC, ARC, or 3D
- Output resolution of 4K @ 30fps, 1080p @ 60 fps, or 720p @ 60fps may be selected per output using KDMS Pro software or by sending command via TCP/IP or RS-232
- Provides 12V Power over CAT to each KD-EXMLVRx
- **Blue** Link LED to the right of port illuminates with active link with KD-EXMLVRx unit
- **Important Notes:**
 - Minimum CAT5e/6 cable length required: 17ft (5m)
 - Not compatible with HDBaseT or third-party Rx. Connecting to incompatible Rx may cause damage and result in void of warranty.

Analog Audio Outputs (4): 6-pin phoenix balance / un-balanced

- Provides 2ch balanced or un-balanced analog audio output from the selected HDMI input source.
- The Pin assignment for the audio is as follows:
 - Left + is Pin 1; Left - is Pin 3; Left Ground is Pin 2.
 - Right + is Pin 4; Right - is Pin 6; Right Ground is Pin 5.

- For un-balanced audio, use the + and Ground pins of each channel
- Drives audio signals up to 2VRMS with a sampling rate of 192KHz
- Up to 255ms of delay may be added per output using KDMS Pro software or by sending command via TCP/IP or RS-232. Delay settings apply to both the analog and digital ports for the output.
- There are no volume or tone control features
- There are no format conversion features. For example, to achieve 2ch analog audio output, the selected HDMI input source audio format must be 2ch.

Digital Audio Outputs (4): Optical

- Provides digital audio output from the selected HDMI input source.
- Supports PCM, SPDIF (IEC 60958), Dolby Digital®, and DTS™ up to 5.1 / 6.1
- There are no volume or tone control features
- There are no format conversion features. For example, to achieve 2ch analog audio output, the selected HDMI input source audio format must be 2ch.

Audio Input Signal Format	Audio L/R Output	Digital Audio Output (Optical)
2ch PCM	Pass-Through	Pass-Through
Multi-Channel PCM	Front L/R Pass-Through	MUTE
Dolby DTS	MUTE	Pass-Through
HD Audio	MUTE	MUTE

IR In/Out (4):

- The default setting is IR Input. Direction may be changed using KDMS Pro software, TCP/IP or RS-232.
- IR In/Out ports correspond to their respective Rx unit. IR is not routable
- RS-232 is not supported
- Only the provided IR Sensor and IR Emitter should be used. Third-party sensors or emitters may not be compatible and/or may result in damage
- The included IR Sensor Receives signals from a 90° angle at up to 30 ft. away.
 - Maximum supported IR burst frequency is 55kHz.
- Pinout:
 - Tip = IR in/out signal, Ring = +5V sensor power, Sleeve = Ground

Service USB (1):

- Micro USB port
- Used for configuration and control from PC via KDMS Pro, KDMS, or third-party control terminal
- Used for firmware updates (consult with Key Digital tech support before updating firmware).
 - **Note:** After updating firmware, all unit settings are restored to defaults except IP information. Please collect all customized settings info before loading firmware.
- Supports USB driver for Windows, Mac
- Will register as “Prolific USB-to-Serial Comm Port in Device Manager

- Can be used as RS-232 control port. Baud rate is 115,200.

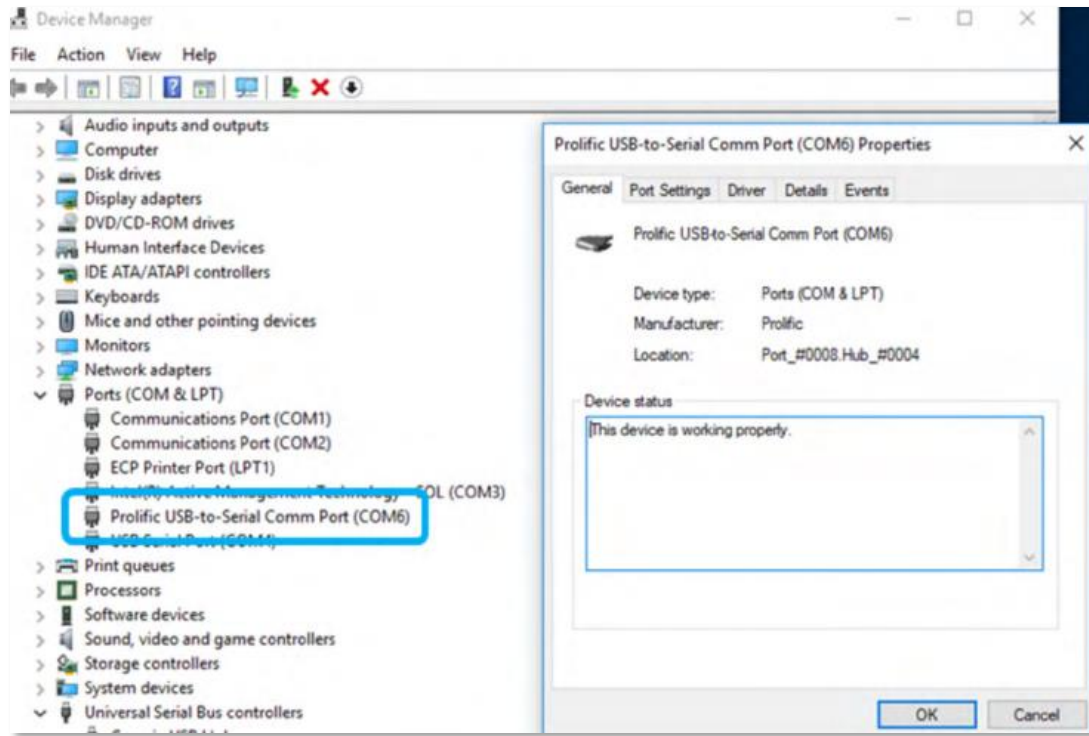

Ground Screw: Connect to ground screw on rack or direct to ground wire from ground post to ensure solid grounding of the main unit.

TCP/IP Unit Control: Used for unit control from a control system and/or PC

- Connect ethernet cable from the KD-MLV4x4Pro to a network router or connect a straight through cable directly from a PC
- Default static IP address is 192.168.1.239, port 23
- Unit configuration, control, and firmware updates are achieved with Key Digital Management Software™ Pro (KDMS™ Pro) downloaded [HERE](#).
- See TCP/IP and RS-232 Commands section for full API

Default static IP address:
192.168.1.239, port 23

RS-232 & IR Unit Control: Used for unit control from a control system and/or PC

- 6-Pin Terminal Block for IR and RS-232
- Pin out:
 - Pin 1 = Serial (Wired) IR In
 - Pin 2 = IR Ground
 - Pin 3 = No Connection
 - Pin 4 = RS-232 Tx Data
 - Pin 5 = RS-232 Ground
 - Pin 6 = RS-232Rx Data
- See TCP/IP RS-232 Commands section for full API

IR Sensor: Mount IR an IR emitter from control system or IR connection block. Refer to IR Remote Control section for correct button press sequence

KD-EXMLVRx Connections, LEDs, and Slide-Switches

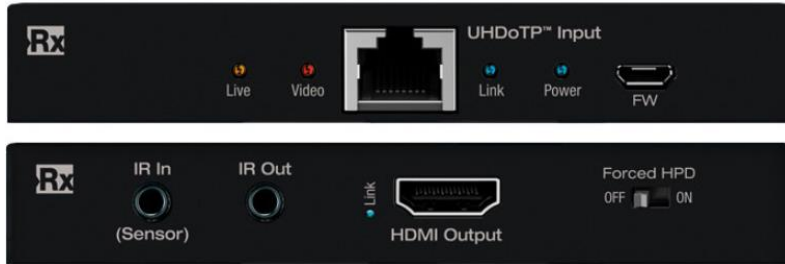

HDMI Output: Using an HDMI cable, connect your HDMI displays.

- Supports up to UHD/4K @ 30fps [4:4:4], 8 bit color, 10.2Gbps maximum bandwidth
- Compliant with HDMI 2.0, HDCP 2.x and previous
- Supports surround audio formats including Dolby®, DTS™ (formats up to 5.1 / 6.1)
- Does not support HDR, CEC, ARC, or 3D
- Output resolution of 4K @ 30fps, 1080p @ 60fps, or 720p @ 60fps may be selected per output using KDMS Pro software or by sending command via TCP/IP or RS-232
- Source selection and down-convert settings are mirrored on UHDoTP and HDMI output connections of the same port number.
- For Display Port monitors use active HDMI to DP converter

UHDoTP Input: Connect a CAT5e/6 cable to the Main unit's UHDoTP Output port using 568-B termination.

- Supports up to UHD/4K @ 30fps [4:4:4], 8 bit color, 10.2Gbps maximum bandwidth
- Compliant with HDMI 2.0, HDCP 2.x and previous
- Distance performance:
 - UHD/4K: Up to 115ft (35m) using CAT5e/6, up to 40m (131ft) using CAT6A STP
 - 1080p: UP to 164 ft (50m) using CAT5e/6, up to 60m (197ft) using CAT6A STP
- Supports Dolby®, DTS™ (5.1 / 6.1 formats max)
- Does not support HDR, CEC, ARC, or 3D
- Output resolution of 4K @ 30fps, 1080p @ 60 fps, or 720p @ 60fps may be selected per output using KDMS Pro software or by sending command via TCP/IP or RS-232
- Provides 12V Power over CAT to KD-EXMLVRx
- **Important Notes:**
 - Minimum CAT5e/6 cable length required: 17ft (5m)
 - Not compatible with HDBaseT or third-party Rx. Connecting to incompatible Rx may cause damage and result in void of warranty.

IR Out:

- Connect the included IR emitter to control your display / projector.
- Pinout: Tip = IR in/out signal, Sleeve = Ground
- If the respective IR In/Out port on KD-MLV4x4Pro has been set to IR Output, this port is no longer active

IR In:

- Connect the included IR sensor to collect line-of-sight IR from your device's remotes
- Pinout: Tip = IR in/out signal, Ring = +5V sensor power, Sleeve = Ground
- By default, this port is not active. You must set the respective IR In/Out port on KD-MLV4x4Pro to IR Output for this port to work.
- Only the provided IR Sensor should be used. Third-party sensors may not be compatible and/or may result in damage
- The included IR Sensor Receives signals from a 90° angle at up to 30 ft. away.
- Maximum supported IR burst frequency is 55kHz.

LEDs

Power (Blue)

- Solid illumination during power on state, as provided by healthy connection with power supply and healthy PoC extension.
- Steady blink if unit has a power short

Link (Blue)

- Solid illumination from healthy UHDoTP link between Tx and Rx units

Video (Red)

- Illumination with active TMDS (video + audio) signal
- Off with no TMDS (video + audio) signal

Live (Amber)

- Steady blink from healthy unit CPU state

HDMI Link (Blue)

- Solid illumination from active Hot Plug Detection voltage with connected display/output device

Forced HPD Slide Switch: In cases of many layers of connectivity or non-standard devices in-line, hot plug detection (HPD) may be lost or drop below standard levels, leading to the video display not detecting a connected source and resulting in no image.

- If set to ON, Hot Plug Detection (HPD) voltage is forced at the HDMI connection of the Rx unit. The connected display will be fed a constant voltage to inform the device that a partner is always connected and active.
- If set to OFF, Hot Plug Detection (HPD) voltage is passed thru from connected source to the display

FW (firmware) USB:

- Micro USB port
- Used for firmware updates (consult with Key Digital tech support before updating firmware)
 - **Note:** After updating firmware, all unit settings are restored to defaults except IP information. Please collect all customized settings info before loading firmware.

Front Panel Control & LCD

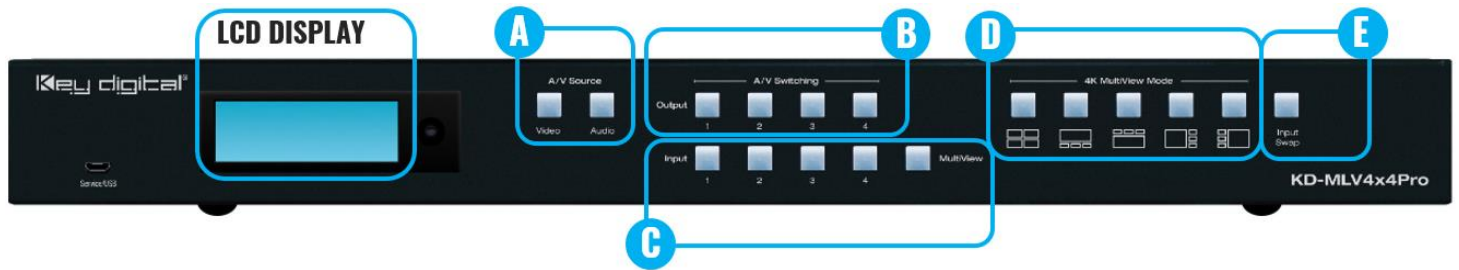

- **Switching / Multi-view select:** HDMI Video & Audio
 1. Video button (section A)
 2. Output button (section B)
 3. Input button (full screen) or MultiView button (section C)
- **Matrix Switching:** External Audio only
 1. Audio button (section A)
 2. Output button (section B)
 3. Input button (section C)
- **Choose multi-view layout for all multi-view zones**
 1. 4K MultiView Mode button (section D)
- **The Input Swap button** (section E) rotates source positioning when in a multi-view layout.
 - When in quad layout, the HDMI audio will be of the source in the top-left position
 - When in multi-view layout, the HDMI audio will be of the source in the large/primary position
 - External audio does not automatically follow the HDMI audio. It must be switched independently.
 - Sources rotate clockwise as pictured:

Multiview (quad) – input swap

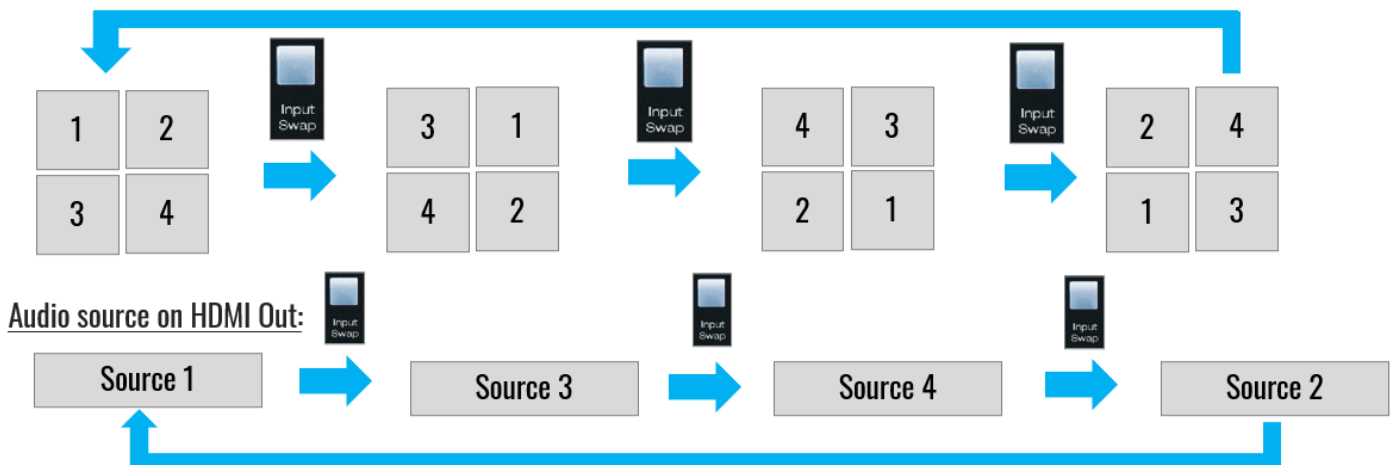

Multiview Video on HDMI Outputs:

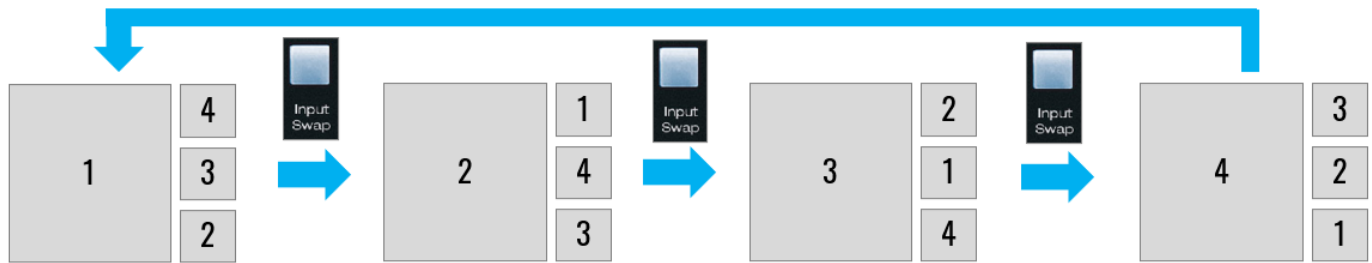

Audio source on HDMI Out:

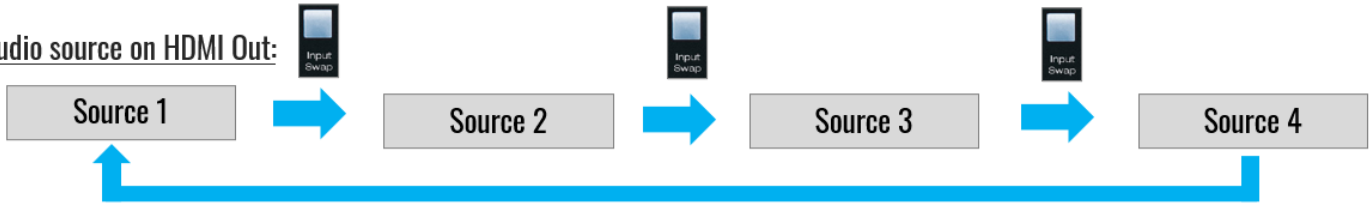

Multiview (right) – input swap

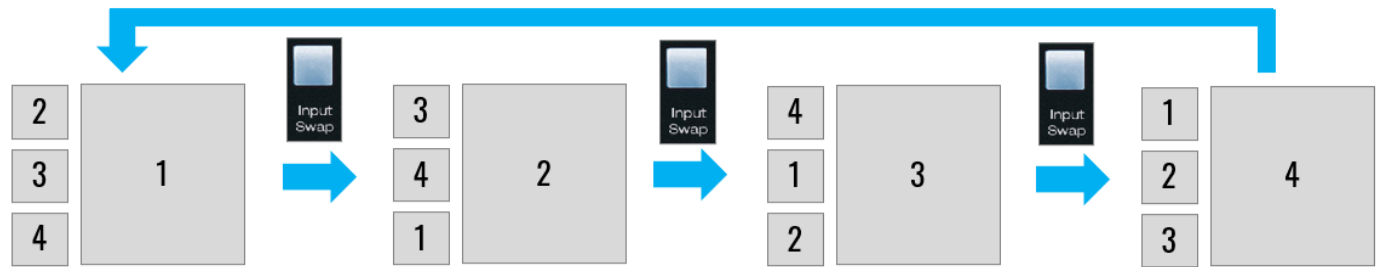

Multiview (up) – input swap

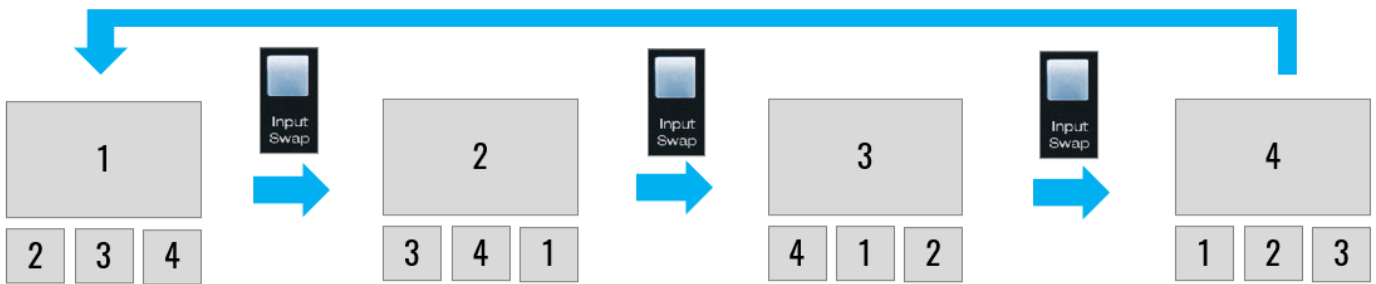

Multiview (down) – input swap

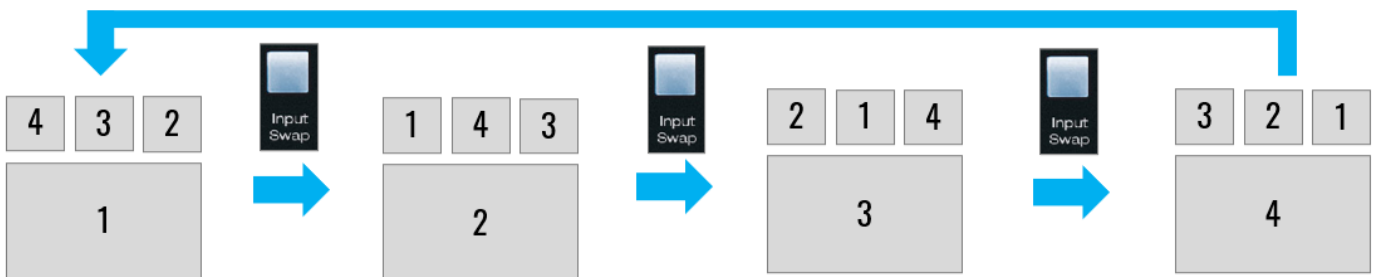

Factory Default Reset via Front Buttons: Simultaneously press & hold the Video and Input Swap buttons for 10 seconds to reset KD-MLV4x4Pro to its factory settings:

- All outputs select source 1
- EDID setting 5 is applied at all HDMI inputs
- IP Address, input & output naming, and all other applied settings are defaulted

LCD Display

- During bootup, the model number and unit's IP address are shown
- During Switching / Multi-View select for video, the selected source number or "MV" is shown for each output
- During Switching for audio, the selected source number is shown for each output

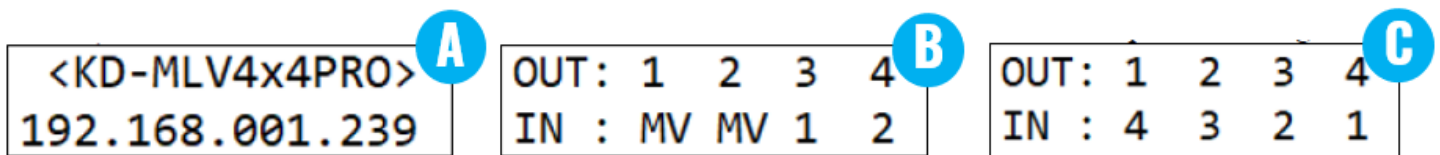

IR Remote Control

- **Switching HDMI AV + External Audio together**
 1. R1 button (section E)
 2. Output button (section B)
 3. Input button (section D)
- **Select multi-view layout** for all multi-view zones
 1. R1 button (section E)
 2. Layout 1-9, using Device Select buttons (section F)
 - 1-5 = same as layouts 1-5 on front panel and pictured below
 - 6-9 = custom layouts
- **Audio Selection in Multi-View mode**
 1. Audio button (section A)
 2. MV button (section C)
 3. Input button (section D)
- **Switching / Multi-view select:** HDMI AV only
 1. Video button (section A)
 2. Output button (section B)
 3. Input button (section D) or MV (section C)
- **Switching:** External Audio only
 1. Audio button (section A)
 2. Output button (section B)
 3. Input button (section D)

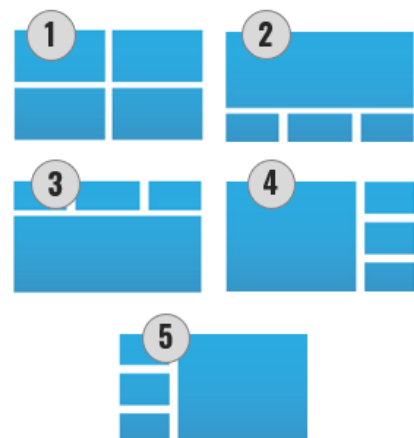
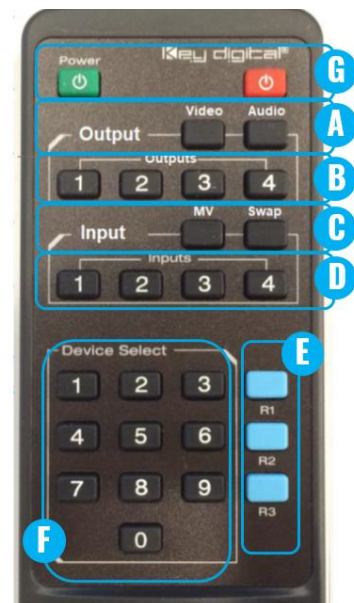

Set EDID via IR remote control: A unique EDID handshake can be chosen for each HDMI input

- To apply EDID handshake from built-in EDID file library:

1. R2 button (section E)
2. R1 button (section E)
3. R3 button (section E)
4. Input button 1-4 (section D)
5. EDID handshake 1-9 (section F), according to EDID table:

EDID #	EDID Handshake Description
1	1080i 60fps with 2ch PCM audio
2	1080i 60fps with PCM, DTS/Dolby surround
3	1080p 60fps with 2ch PCM audio
4	1080p 60fps with PCM, DTS/Dolby surround
5	4Kx2K 60fps with 2ch PCM audio
6	4Kx2K 60fps with PCM, DTS/Dolby surround
7	DVI 1280x720 60fps, no audio
8	DVI 1920x1080 60fps, no audio

- To apply EDID handshake copied from a display/projector connected to an HDMI output:

1. R2 button (section E)
2. R1 button (section E)
3. R3 button (section E)
4. Input button 1-4 (section D)
5. Output button 1-4 (section B)

Web UI

Use the web UI to control AV routing and other basic functionality, as well as set custom multi-view layouts and adjust IP settings from any web browser.

- The Web UI displays the names of the unit (A), and of each output (B) and input (C).
 - Names may be updated using KDMS Pro software, as instructed in the Configure section of the Quick Setup Guide.

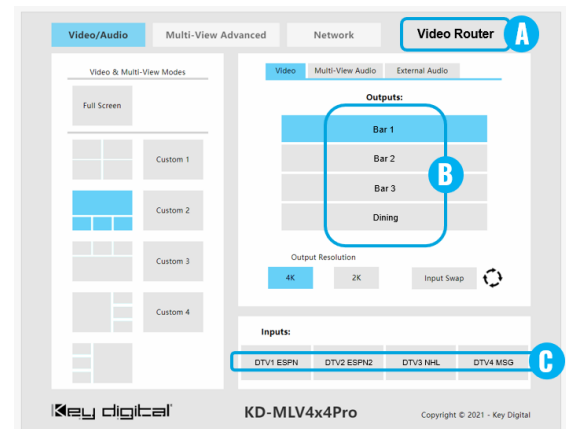

1. Open web browser and enter KD-MLV4x4Pro's IP address.
 - o The Default IP address is 192.168.1.239
 2. Enter password. The default password is **admin** and may be adjusted in the network settings.
- For **HDMI AV switching control**:
 1. Enter Video tab
 2. Select desired output
 3. Select Full Screen or desired MultiView layout
 4. If Full Screen, choose the desired Input
 - For **Multi-View Audio selection**, the selected Input source applies to all MultiView zones
 - For **External Audio switching control**, first select the desired Output, then choose the desired Input

Multi-View Advanced Tab

Create and save custom multi-view layouts using the following tools:

Multi-View Window Placement:

- An X/Y axis is used, enabling control of each pixel of 3840x2160 screen
- The pixel count begins at 0
 - X0/X1 range = 0–3839
 - Y0/Y1 range = 0-2159
- X0 = Desired location of the Top-Left handle of the window, from Left to Right horizontally across the screen
- Y0= Desired location of the Top-Left handle of the window, from Top to Bottom vertically across the screen
- X1 = Desired location of the Bottom-Right handle of the window, from Left to Right horizontally across the screen
- Y1= Desired location of the Bottom-Right handle of the window, from Top to Bottom vertically across the screen

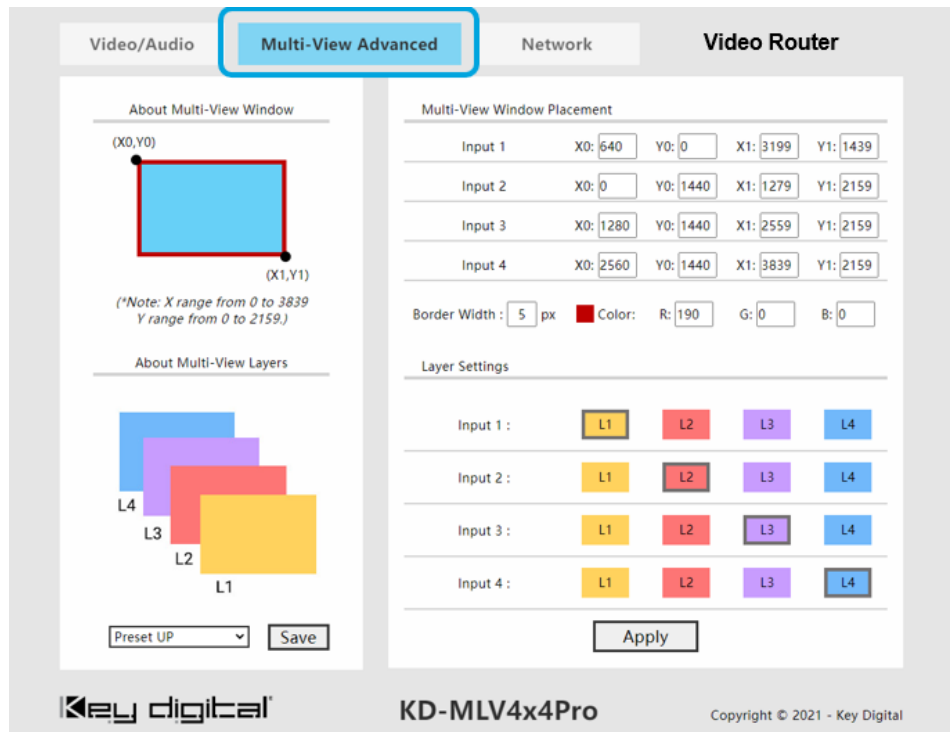

Layer Settings:

- 1 = Top / front layer
- 4 = Bottom / back layer

Apply Button sends the layout to the HDMI output that is currently selected in the Video/Audio tab, Video sub-section

Save Button saves the specified layout to the preset currently selected in the dropdown menu

Note about Layering: Each HDMI output may have unique layering settings. You may set for each by entering the Video/Audio tab, Video sub-section and selecting an HDMI output, then applying the layering as desired.

Border Width and Color

- Border width = 0-9 pixels. If 0, then there is no border applied
- Color uses a decimal value RGB code chart, with the value of 0-256 for each
 - You may reference an [online RGB Color Codes](#) chart for more information

Additional References are currently available for the KD-MLV4x2Pro (previous generation product). You can follow these documents but multiply each X/Y pixel value by 2 since multi-view mode for KD-MLV4x2Pro was 1080p, and KD-MLV4x4Pro multi-view mode is 4K. Documents will be updated ASAP and linked in future manual revisions.

- [Custom Presets Quick Guide](#) provides in-depth explanation on X/Y axis location and calculation
- [Common Custom Presets](#) provides X/Y values for commonly used custom layouts

Network Tab

View and/or update IP settings for the KD-MLV4x4Pro.

The screenshot shows the 'Network' tab selected in the 'Video Router' interface. The 'Network Configuration' section includes the following fields:

Mac Address :	60:89:B1:40:0D:75
Host IP Address :	192.168.1.200
Subnet Mask :	255.255.255.0
Router IP Address :	192.168.1.1
TCP Port :	23

An 'Apply' button is located below these fields.

The 'Admin Password' section includes the following fields:

Old Password :	<input type="password"/>
New Password :	<input type="password"/>
Confirm Password :	<input type="password"/>

An 'Apply' button is located below these fields.

At the bottom of the interface, the 'Key digital' logo, 'KD-MLV4x4Pro' model name, and 'Copyright © 2021 - Key Digital' are visible.

TCP/IP and RS-232 Commands

TCP/IP Connection Protocol

- Default IP address = 192.168.1.239
- TCP/IP Port Number = 23 (TCP protocol)

Default static IP address:
192.168.1.239, port 23

RS-232 Connection Protocol

- Baud Rate = 57,600 bits per second as default
- Data Bits = 8
- Stop Bits = 1
- Parity = None
- Flow Control = None
- Carriage Return = Required at end of each string

Notes:

- Commands are not case-sensitive
- Spaces are shown for clarity; commands should NOT have any spaces
- After a new command is received, a prompt should be sent back

Help Command (H). Returns entire API in readable format:

```

-----
--                               Key Digital Systems HELP                               --
-----
--  KD-MLV4x4Pro                               F/W Version : 1.12  --
--
--  H      : Help                               --
--  STA    : Show Global System Status         --
--  PF     : Power Off                          --
--  PN     : Power ON                           --
--
--  Video Input Setup Command :                               --
--  ( xx=[01~04,A=A11], aaaa=[0001~3840], bbbb=[0001~2060], yy=[10~99] )--
--  SPI xx ON/OFF   : Set Input xx ON/OFF      --
--  SPI xx OSD ON/OFF : Set Input xx OSD to ON/OFF  --
--  SPI xx OSP aaaa.bbbb : Display Input xx Name at X/Y-axis(aaaa/bbbb) --

```

```

-- SPI xx OSS y : Set Font Size of Input xx OSD by y=[1~3] --
--           y[1=12x24px, 2=24x48px, 3=48x96px] --
-- --
-- Video Output Setup Command : --
-- (xx=[01~04,A=All], yy=[01~05, 05=Multiview]) --
-- SPO xx SB yy      : Set Video Output xx to Input yy --
-- SPO xx SI yy      : Set Video-Audio Output xx to Input yy --
-- SPO xx PG y       : Set Video Output xx with Video Pattern y=[0~9] --
-- (0=OFF, 1=Back Screen, 2=Horizontal Gray Bars --
-- (3=Horizontal Gray Scale, 4=Vertical Gray Scale, 5=Color Bars ) --
-- (6=Red Screen, 7=Green Screen, 8=Blue Screen, 9=Grid ) --
-- SPO xx VF yy      : Set Video Output xx to Video Format yy --
-- [ yy : 01 = 4K@30, 02 = 1080p@60, 03 = 720p@60 ] --
-- SPO xx DBG ON/OFF : Set Video Output xx's Debug Mode to ON/OFF --
-- --
-- Audio Output Setup Command : (xx=[01~04,A=All], yy=[01~04]) --
-- SPO xx SA yy      : Set Audio Output xx to Input yy --
-- SPO xx HA E/D     : Set HDMI/UHDoTP Audio Output xx to Enable/Disable --
-- SPO xx AA E/D     : Set Balanced Audio Output xx to Enable/Disable --
-- SPO xx DA E/D     : Set Optical Output xx to Enable/Disable --
-- --
-- IR Setup Command : (xx=[01~04,A=All], y=[1~2]) --
-- SPO xx IRS y      : Set Output xx IR Direction to y [1=IN, 2=OUT] --
-- --
-- Multiview Mode Setup Command : ( xx=[01~04], z=[1~9] ) --
-- ( z: 1=QUAD, 2=UP, 3=DOWN, 4=LEFT, 5=RIGHT, 6~9=MANUAL1~4 ) --
-- SPM AS xx        : Set Audio Input xx on Multiview --
-- SPM A E/D        : Set Audio Output Enable/Disable on Multiview --
-- SPM AD zzz       : Set Audio Delay by zzz=[000~255]ms --
-- SPM VIS          : Set Input Swap --
-- SPM VSM z        : Set Multiview Mode by Preset z --
-- --
-- Multiview Screen User Setup Command : --
-- ( xx=[01~04], aaaa=[0000~3839], bbbb=[0000~2159] ) --
-- ( cccc=[0000~3839], dddd=[0000~2159], z=[0~9] ) --

```

```

-- SPM xx XY aaaa.bbbb.cccc.dddd : Set Start of X/Y-axis by aaaa/bbbb--
    and End of X/Y-axis by cccc/dddd for Input xx on Multiview Screen --
-- SPM BLW z      : Set Border Line Width by z [0=None, 1~9 Pixels] --
-- SPM BLC rrr.ggg.bbb : Set Border Line Color by RED/GREEN/BLUE --
    ( rrr=[000~255], ggg=[000~255], bbb=[000~255]          ) --
-- SPM PT abcd    : Set Priority of Inputs by abcd [1234~4321] --
-- SPM VSS z     : Save User Multiview Screen to Preset z, (z=[1~9]) --
--
-- Input/Output/Device Naming Commands (Max. 16 Chars) --
-- SPI xx WN cccccccccccccccc : Write Input xx Name --
-- SPI xx RN                   : Read Input xx Name --
-- SPO xx WN cccccccccccccccc : Write Output xx Name --
-- SPO xx RN                   : Read Output xx Name --
-- SPC WN cccccccccccccccc    : Write Device Name --
-- SPC RN                      : Read Device Name --
--
-- Network Setup, ( xxx=[000-255], zzzz=[0001~9999] ) --
-- SPCETIPA xxx.xxx.xxx.xxx : Set Host IP Address to xxx.xxx.xxx.xxx --
-- SPCETIPM xxx.xxx.xxx.xxx : Set Net Mask to xxx.xxx.xxx.xxx --
-- SPCETIPR xxx.xxx.xxx.xxx : Set Route IP Address to xxx.xxx.xxx.xxx --
-- SPCETIPP zzzz            : Set TCP/IP Port to zzzz --
-- SPCETIPB                 : Apply New Network Config --
--
-- EDID Setup Command ( xx=[01~04,A=All], yy=[01~04], zz=[01-08] ) --
-- SPCEDID xx H yy : Copy EDID from HDMI Ouput yy to Input xx --
-- SPCEDID xx C yy : Copy EDID from UHDoTP Ouput yy to Input xx --
-- SPCEDID xx D zz : Copy EDID from Default EDID zz to Input xx --
-- DEFAULT EDID 01 : HDMI 1080i@60, 2CH PCM Audio --
-- DEFAULT EDID 02 : HDMI 1080i@60, Audio PCM,DTS/DOLBY --
-- DEFAULT EDID 03 : HDMI 1080p@60, Audio 2CH PCM Audio --
-- DEFAULT EDID 04 : HDMI 1080p@60, Audio PCM,DTS/DOLBY --
-- DEFAULT EDID 05 : HDMI 4Kx2K@60/10G, 2CH PCM Audio --
-- DEFAULT EDID 06 : HDMI 4Kx2K@60/10G, PCM,DTS/DOLBY --
-- DEFAULT EDID 07 : DVI Video Max. 1280x720@60, No Audio --
-- DEFAULT EDID 08 : DVI Video Max. 1920x1080@60, No Audio --

```

```
--
-- System Control Setup Commands: ( z=[0~4] )
-- SPCFB E/D      : Set Front Panel Buttons E/D (E=Enable,D=Disable)
-- SPCFD ON/OFF  : Set Front LCD Backlight and LEDs ON/OFF
-- SPC RSB z      : Set Main RS232 Baud Rate to z bps, z=[0-4]
--                [0:57600, 1:38400, 2:19200, 3:9600, 4:4800]
-- SPCDF          : Reset All Settings to Factory Default
-- SPCDF 00       : Reset All Settings except of Network/Naming Setting
```

Status Command (STA). Returns unit status and settings in readable format:

```
-----
--                               Key Digital Systems STATUS                               --
-----
-- Model: KD-MLV4x4Pro,           Device Name: MLV4x4PRO_0001
-- Main F/W Ver: 1.12,
--
-- RS232 : Baud Rate=57600bps, Data=8bit, Parity=None, Stop=1bit
-- Front Panel Button : Enabled
-- Front LCD Display Backlight : ON
--
-- Network Setting(Telnet Server) Status
-- MAC Address = 60:89:B1:40:0D:75
-- Host IP Address = 192.168.001.200
-- Net Mask = 255.255.255.000
-- Router IP Address = 192.168.001.001
-- TCP Port = 0023
--
-- Video Input Status
-- 01: EDID = DEFAULT05, Link = ON, Video Format = 4K
--     OSD = ON , Size = 3, XY = (0100,0100), Name = Input 01
-- 02: EDID = DEFAULT05, Link = ON, Video Format = 4K
--     OSD = ON , Size = 3, XY = (2020,0100), Name = Input 02
-- 03: EDID = DEFAULT05, Link = ON, Video Format = 4K
--     OSD = ON , Size = 3, XY = (0100,1180), Name = Input 03
-- 04: EDID = DEFAULT05, Link = ON, Video Format = 4K
--     OSD = ON , Size = 3, XY = (2020,1180), Name = Input 04
--
-- Video Output Status
-- 01: Input = 01, Link = ON , Output = ON , Video Format = 4K
--     Multiview = QUAD , PG = 0, Name = Display 01
-- 02: Input = 01, Link = ON , Output = ON , Video Format = 4K
--     Multiview = QUAD , PG = 0, Name = Display 02
-- 03: Input = 01, Link = ON , Output = ON , Video Format = 4K
```

```

--      Multiview = QUAD      , PG = 0, Name = Display 03      --
-- 04: Input = 04, Link = ON , Output = ON , Video Format = 4K  --
--      Multiview = QUAD      , PG = 0, Name = Display 04      --
--      --      --
-- External Audio Output Status      --
-- 01 : Input = 01, Balanced = Enable, PCM(Coax) = Enable      --
-- 02 : Input = 02, Balanced = Enable, PCM(Coax) = Enable      --
-- 03 : Input = 03, Balanced = Enable, PCM(Coax) = Enable      --
-- 04 : Input = 04, Balanced = Enable, PCM(Coax) = Enable      --
--      --      --
-- External IR In/Out Status      --
-- 01 : Serial IR IN      --
-- 02 : Serial IR IN      --
-- 03 : Serial IR IN      --
-- 04 : Serial IR IN      --
--      --      --
-- Multiview Mode Status      --
-- Predefined Screen Mode = QUAD      --
-- Border Line = 5 , Border Color = 150.250.000      --
-- Priority = 1234      --
-- Multiview Audio Input = 01, Audio Output = Enable, A/D = 30ms  --
--      --      --
-- Multiview Screen Manual Setup Command      --
-- 01: SX = 0000, SY = 0000, EX = 1919, EY = 1079, Priority = 1  --
-- 02: SX = 1920, SY = 0000, EX = 3839, EY = 1079, Priority = 2  --
-- 03: SX = 0000, SY = 1080, EX = 1919, EY = 2159, Priority = 3  --
-- 04: SX = 1920, SY = 1080, EX = 3839, EY = 2159, Priority = 4  --
-----

```

Text Overlay

Text overlay available while in multi-view mode.

- The assigned name of each source may be displayed in each window.
- Use KDMS Pro or send commands via IP/RS-232 to set the name of each source, X/Y location of each text box, and to enable/disable the text overlay setting
- 16 characters maximum with variable sizing (large / medium / small).
 - The below image is an example of “large” text overlay applied.

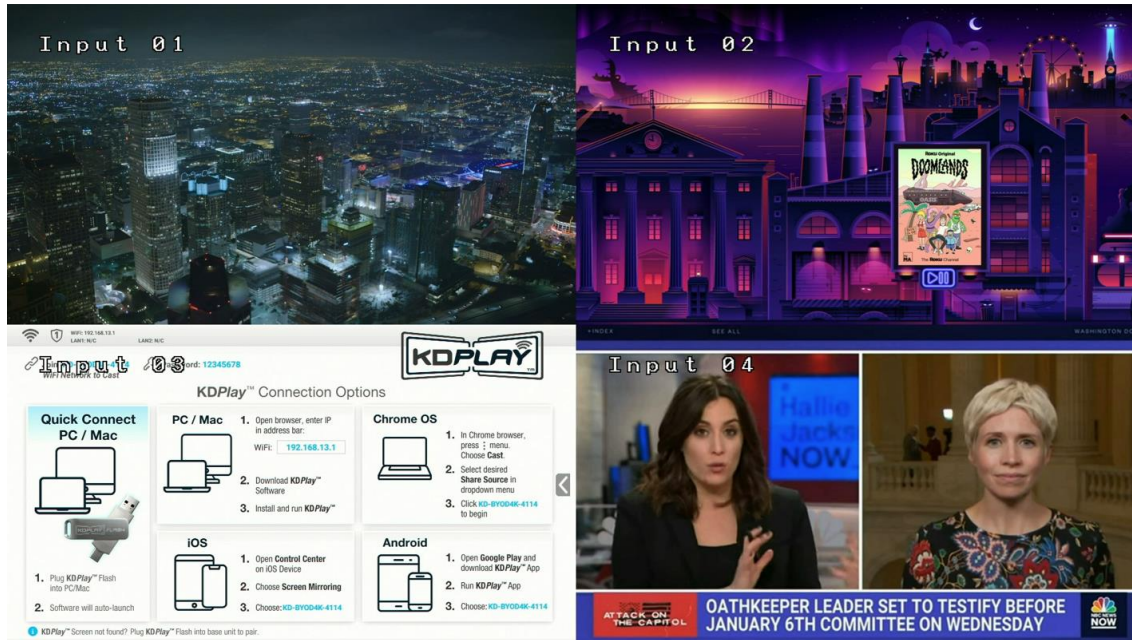

- Each Multiview layout may have a unique text overlay location
- The below table has the default settings per each multi-view preset (regardless of 4K, 1080p, or 720p output resolution).

Multi-view Preset	Input 1		Input 2		Input 3		Input 4	
	X	Y	X	Y	X	Y	X	Y
1 (Quad)	100	100	2020	100	100	1180	2020	1180
2 (Top)	740	100	100	1540	1380	1540	2660	1540
3 (Bottom)	740	820	2660	100	1380	100	100	100
4 (Left)	100	460	2660	1540	2660	820	2660	100
5 (Right)	1380	460	100	100	100	820	100	1540
6 (custom)	100	100	2020	100	100	1180	2020	1180
7 (custom)	100	100	2020	100	100	1180	2020	1180
8 (custom)	100	100	2020	100	100	1180	2020	1180
9 (custom)	100	100	2020	100	100	1180	2020	1180

Integrating with AV over IP Systems

If AV over IP decoders feed into KD-MLV4x4Pro's HDMI inputs as pictured in the below diagram image jitter may occur. Disable TruMotion features on each display to resolve.

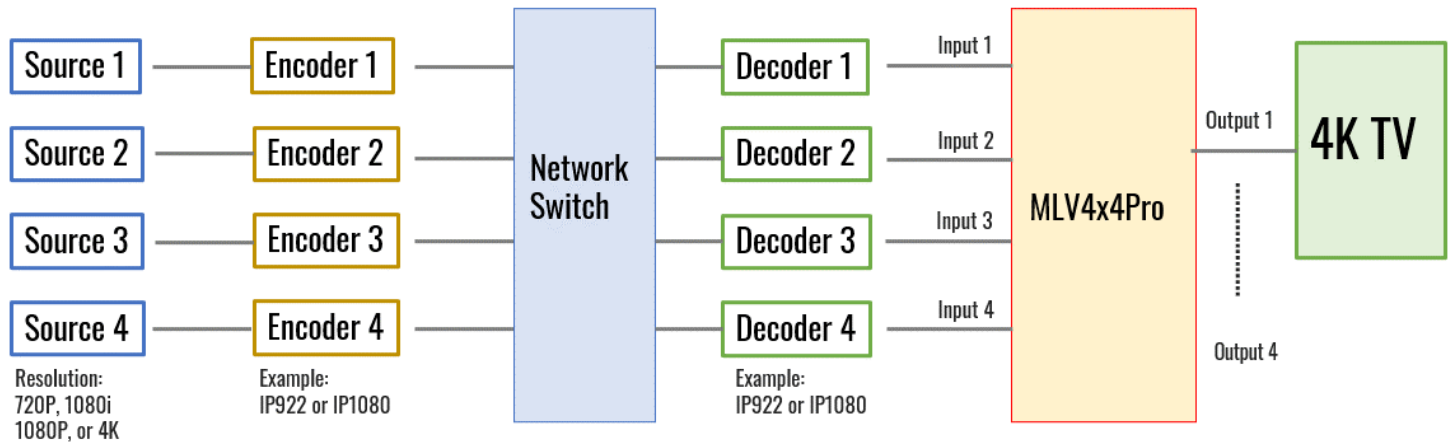

- **LG:** Settings > Picture > Picture Mode Settings > Picture Options > TruMotion > Off

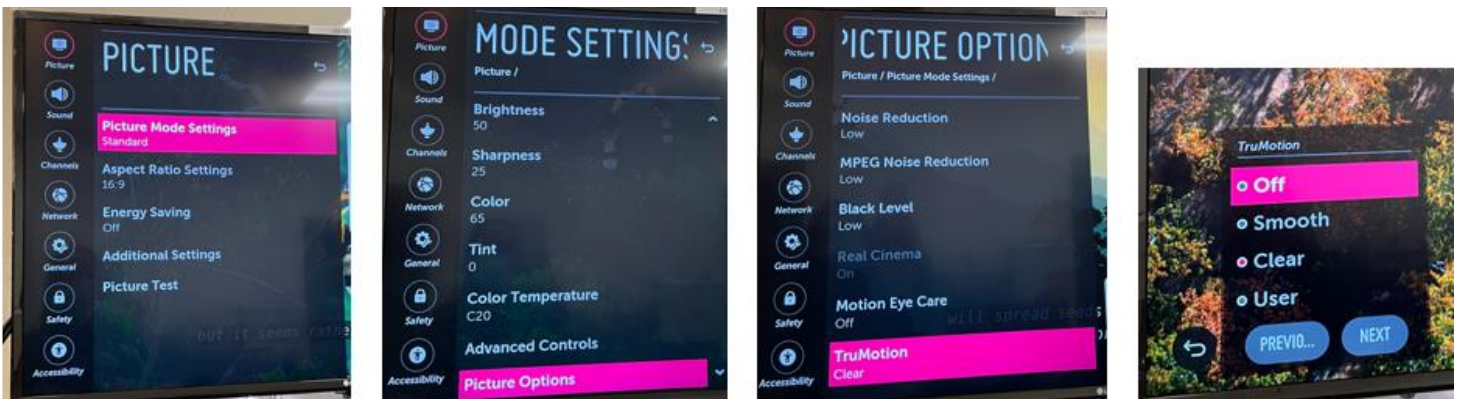

- **Samsung:** Settings > Picture > Expert Settings > Auto Motion Plus Settings > Auto Motion Plus > Off



- **Sony:** Settings > Picture & Display > Picture Adjustment > Advanced Settings > Motion > Motionflow OFF

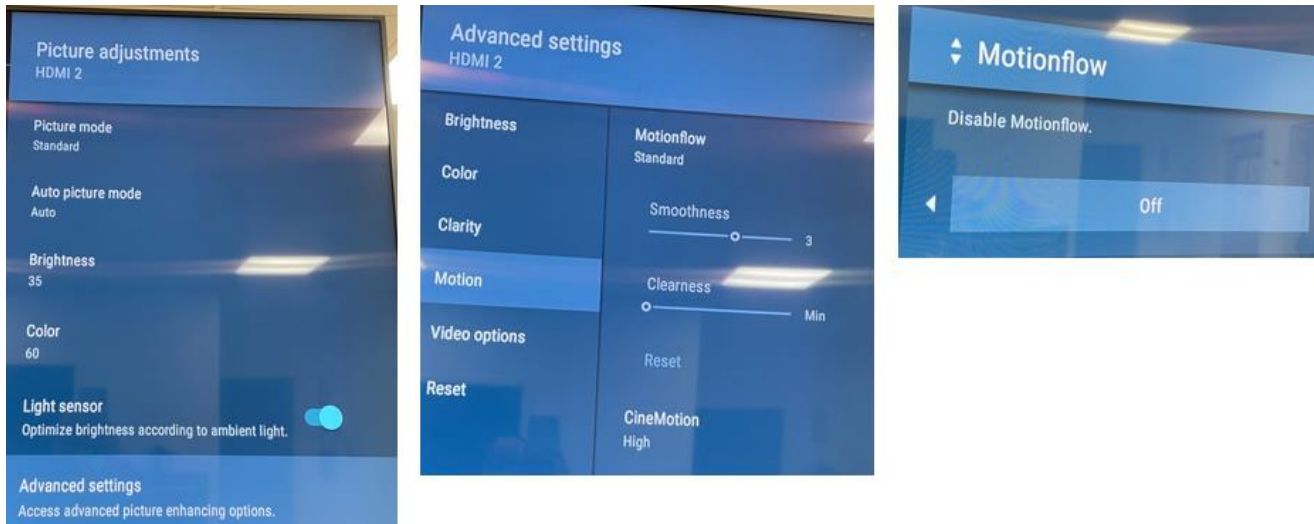

Specifications

Technical

- Input (Each): 1 HDMI Connector, Type A, 19 Pin Female
- Output (Each): 1 HDMI Connector, Type A, 19 Pin Female
- Output (Each): Balanced/unbalanced line level audio on 6-pin terminal block. Drives 2VRMS line audio input with a sampling rate of 192KHz
- Output (each): Toslink optical digital audio following SPDIF format (IEC 60958). Supports sampling rate up to 192KHz
- Video Bandwidth: TMDS bandwidth 10.2 Gbps
- DDC Signal (Data): Input DDC Signal - 5 Volts p-p (TTL)
- HDMI Video/Audio Signal: Input Video Signal - 1.2 Volts p-p
- DDC Communication: EDID and HDCP Bi-directional buffering to Display and Source
- Analog Audio Max Output Level: 4dBu on 150kΩ, DC coupling
- Audio Bandwidth: 20Hz to 20kHz @ 0dBu
- TND + Noise: 0.33% @0dBu @ 1kHz » PCM Max Input Level: 1Vpp on 75Ω, AC coupling
- Optical Max Output Level: 1Vpp on 75Ω, DC coupling
- Wired IR: modulated IR signal input, 0-5V TTL or -10 to +10V
- Power: 12V/5 (60W) AC Power Supply with Grounded, 2.1mm ID DC Power Jack with Screw In Type

General

- Regulation: CE, RoHS, WEEE, EAC
- Product Dimensions (LxWxH): 17.24 x 10.78 x 1.73" (438 x 237.7 x 44mm)
- Product Weight: Weight: 8.02 lbs / 3.64 kg
- Packaging Dimensions (LxWxH): 19.69 x 14.72 x 5.12" (500 x 374 x 130mm)
- Packaging Weight: 13.93 lbs / 6.32 kg

Warranty Information

All Key Digital® products are built to high manufacturing standards and should provide years of trouble-free operation. They are backed by a Key Digital Limited 3 Year Product Warranty Policy.

<http://www.keydigital.com/warranty.htm>

Product Warnings & Safety Instructions



Important Product Warnings:

1. Connect all cables before providing power to the unit.
2. Test for proper operation before securing unit behind walls or in hard to access spaces.
3. If installing the unit into wall or mounting bracket into sheet-rock, provide proper screw support with bolts or sheet-rock anchors.



Safety Instructions:

Please be sure to follow these instructions for safe operation of your unit.

1. Read and follow all instructions.
2. Heed all warnings.
3. Do not use this device near water.
4. Clean only with dry cloth.
5. Install in accordance with the manufacturer's instructions.
6. Do not install near any heat sources such as radiators, heat registers, stoves, or other apparatus (including amplifiers) that produce heat.
7. Only use attachments/accessories specified by the manufacturer.
8. Refer all servicing to qualified service personnel. Servicing is required when the device has been damaged in any way including:
 - Damage to the power supply or power plug
 - Exposure to rain or moisture



Power Supply Use:

You MUST use the Power Supply provided with your unit or you VOID the Key Digital® Warranty and risk damage to your unit and associated equipment.

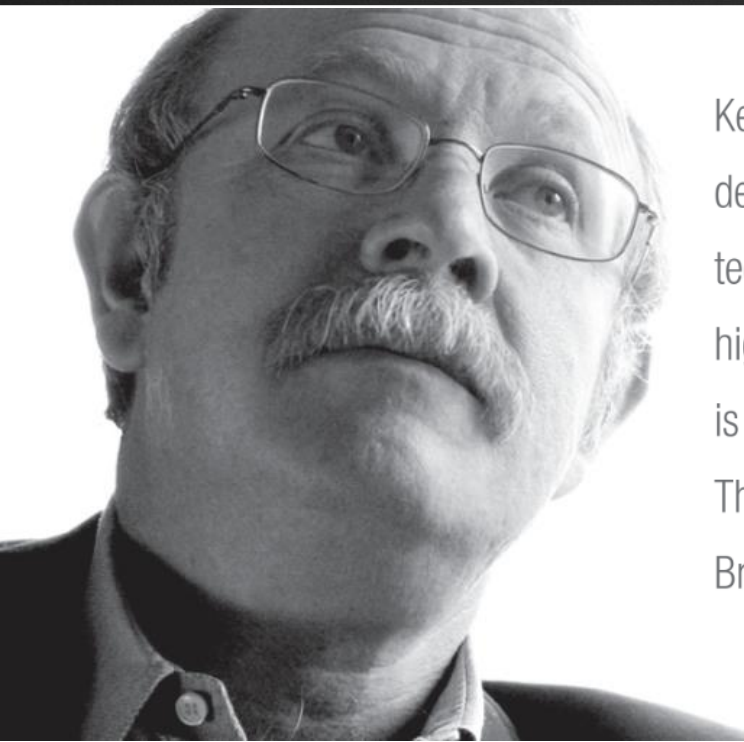

Key Digital[®], led by digital video pioneer Mike Tsinberg, develops and manufactures high quality, cutting-edge technology solutions for virtually all applications where high-end video and control are important. Key Digital[®] is at the forefront of the video industry for Home Theater Retailers, Custom Installers, System Integrators, Broadcasters, Manufacturers, and Consumers.

Key digital[®]

The Experts in Digital Video Technology and Solutions[™]