

# MOTION SENSOR 360 (0-10V LUX)

M360-W-0-10V (WHITE)

FARADITE

## OVERVIEW



The Faradite Motion Sensor 360 (0-10V LUX) is a low profile passive infrared ceiling mounted motion sensor with an integrated 0-10V (0-1000 Lux) light sensor. It's designed for use with home/building automation systems.

## TECHNICAL DATA

Power supply (consumption)	12V-24V DC @ 24V (3mA)
Motion output voltage	12V-24V DC
Max. motion output current	80ma
Lux range	0 Lux (0V) - 1000 Lux (10V)
Ambient temperature	-15-50 °C (Indoor Only)
IP Rating	IP20
Range (Note 1)	5m
Max mounting height	3m (For optimal performance)
Motion output timeout	1 second
Mounting hole	35mm / 1 1/2" (Fire rated: 40mm)
Push-fit connector	AWG 20- 24 CAT5 / CAT6 / CAT7
Standards	EN 61000-6-1 EN 61000-6-3

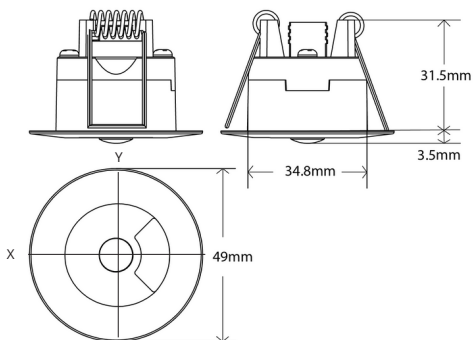

## OBSERVATION AREA

At 2.5M it gives a 5.6M \* 6.6M observation area.

At 3M it gives a ~8M diameter, as shown below.

The following conditions have to be met to detect motion:

1. Movement speed: 1.0m/s
2. Target concept is a human body (Min object size: ~700x250mm)
3. The temperature difference between the target and the surroundings must be greater than 4 °C when mounted at 5m

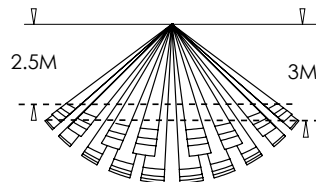

2.5M Height - Observation area

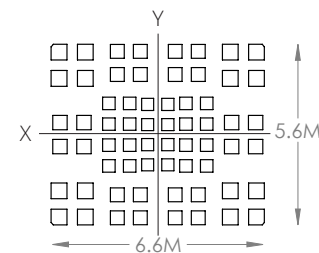

3M Height - Observation area

## ELECTRICAL CONNECTIONS

It is recommended to use CAT cable to connect the motion sensor to the building automation system.

- 1: Strip the cable back 6mm
- 2: Push into circular hole on the connector
- 3: To remove the wire insert the supplied tool or a small screwdriver in the slot behind the wire
- 4: The connector can be removed from the motion sensor by pulling it

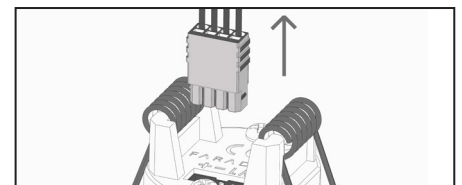
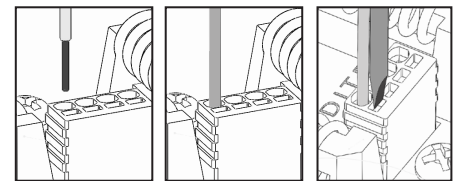

Pull to remove connector from motion sensor

## FIRE RATING

The stand-alone Motion Sensor 360 is not fire rated.

To achieve a 60 minute fire rating to BS 476: Part 21 1987, the optional Fire IDR must be fitted to the Motion Sensor 360.

The Fire IDR is an optional extra.

## EQUIVALENT CIRCUIT

- M MOTION
- L LUX 0V - 10V
- 0V/GND
- + 12V-24V DC

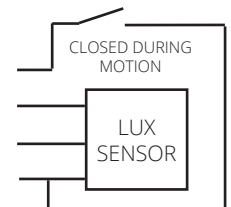

## MOTION OUTPUT

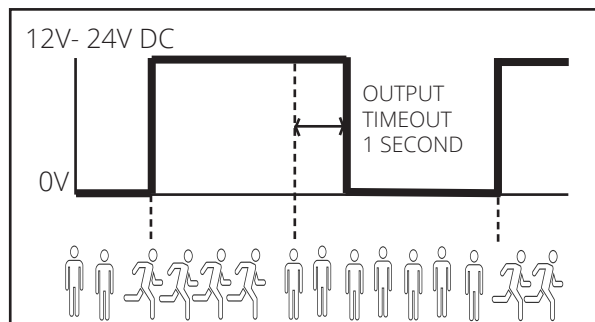

## LUX OUTPUT

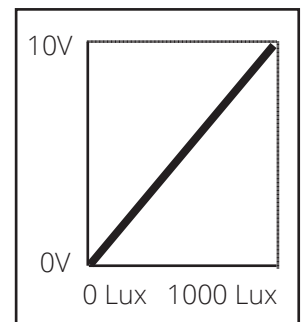

Note 1: Please note that the specified range is 5m but under optimal conditions the sensor might detect movement at a much longer range

## INSTALLATION



To install the Faradite Motion Sensor 360, cut a 35mm / 1 1/2" hole using a suitable hole saw. Fold the spring clips upwards and push through the hole. If you are using the optional Fire IDR to achieve a 60 minute fire rating to BS 476: Part 21 1987, then a 40mm hole will be required (UK only).

## MOUNTING & SAFETY PRECAUTIONS

1) Do not under any circumstance use these sensors outside the range of their ratings shown in the technical data.

2) Faradite is committed to making products of the highest quality and reliability. Nevertheless, all electrical components are subject to natural deterioration, and the product durability will depend on the operating environment and conditions of use.

3) Please note that the sensor can detect heat sources other than the human body, such as:

- a) Small animals
- b) Direct sun light, incandescent lamps, car headlights (even if the heat source is outside the detection area)
- c) Sudden temperature change inside or around the detection area i.e. hot or cold winds/drafts or vapour from the humidifier can effect the performance of the sensor.

4) Please note that the sensor will have difficulty sensing the heat source if it is behind glass, acrylic or similar materials as these materials may not allow a correct transmission of infrared rays.

## SENSITIVITY ADJUSTMENT

The sensor has been designed for optimal sensitivity. It is not recommended to change the sensitivity setting unless it is found to be necessary. To adjust the sensitivity, remove the two screws and turn over the circuit board. The small potentiometer can be used to adjust the sensitivity.



## CONNECTION TO LOXONE MINISERVER

Connection to Loxone is simple: connect the motion output to a digital input and the lux sensor output to an analogue input. There is no need to invert the input as the motion sensor is logic high for motion - see motion output diagram.

*Simply connect directly using a CAT cable; no pull-up resistors required*

FARADITE MOTION SENSOR 360		LOXONE
MOTION	—————	DIGITAL INPUT
LUX 0V - 10V	—————	ANALOGUE INPUT
0V / GND	—————	GND
12V-24V	—————	24V

## LOXONE CONFIG ADJUSTMENT OF ANALOG INPUT

The analog input needs to be mapped correctly so 10V is interpreted as 1000 Lux. **To do this:** click on the correct analog input, which will bring up the properties on the left hand side of the Loxone config. Find the correction section and change the "Display Value 2" to 1000 (instead of 10).

## CONNECTION TO LOXONE NANO DI TREE

If you are installing Faradite TAP-5 / TAP-1 switches as well, the recommended option is to connect the Motion Sensor 360 to the 6th Digital input of the Nano DI Tree module. **Please note that Loxone Nano DI Tree module does not have an analog input for the Lux sensor**

FARADITE MOTION SENSOR 360		NANO DI TREE
MOTION	—————	6th INPUT (BLACK WIRE)
0V /GND	—————	GND (WHITE WAGO)
12V-24V DC	—————	24V (ORANGE WAGO)

## CONNECTION TO CONTROL4

Connection to Control4 is simple, the motion sensor output can be connected to a contact closure on a Control4 I/O module. The 0-10V LUX sensor can be used with Control4 using a driver from Janus Technology. The driver allows for connection of the 0-10V and digital input via devices from Brainboxes Ltd. Search online for Faradite Janus Technology for more info.

FARADITE MOTION SENSOR 360		CONTROL4
MOTION	—————	Brainboxes ED588 - Digital Input OR Control4 - Contact Closure
LUX 0V-10V	—————	0-10V - Brainboxes ED549
0V /GND	—————	GND
12V-24V DC	—————	12V

Directive 2014/30/EU (Electromagnetic Compatibility (EMC))

Directive 2012/19/EU (WEEE)

Directive 2011/65/EU (RoHS)

Harmonised standards: EN 61000-6-1 Immunity for residential, commercial and light-industrial environments & EN 61000-6-3 Emission standard for residential, commercial and light-industrial environments



**RoHS** **CE**